

Camillo FIORENTINI

## HYPERCANONICITY, EXTENSIVE CANONICITY, CANONICITY AND STRONG COMPLETENESS OF INTERMEDIATE PROPOSITIONAL LOGICS

**A b s t r a c t.** Canonicity and strong completeness are well-established notions in the literature of intermediate propositional logics. Here we propose a more refined classification about canonicity distinguishing some subtypes of canonicity, we call hypercanonicity and extensive canonicity. We provide some semantical criteria for the classification of logics according to these notions and we provide applications to the logics in one variable, the logics in one variable with bounded depth, Medvedev logic and the logic of rhombuses.

### 1. Introduction

Canonicity and strong completeness are well-established notions in the literature of propositional modal logics (see for instance [5]) and intermediate propositional logics (see [3]). Indeed, canonicity implies strong completeness and strong completeness implies Kripke completeness, while the

---

*Received 7 November 1999.*

converse of both implications does not hold [2, 20]; thus, such notions play a central role as concerns the relationships between the syntactical apparatus of a logic and its semantical counterpart. In the present paper we investigate some questions related to the canonicity and strong completeness of intermediate propositional logics; the techniques here developed are quite general and we think they can be easily applied to modal logics, temporal logics and whenever Kripke semantics is adopted.

We follow and integrate the ideas explained in [10] where an original approach in the treatment of the subject is proposed. To exemplify, according to the standard definition, a logic  $L$  is canonical if the canonical model of  $L$  is based on a frame for  $L$ ; equivalently,  $L$  is canonical if any Kripke model  $\underline{K}$  of  $L$  such that (i)  $\underline{K}$  is *well separable* and (ii)  $\underline{K}$  is *full* is based on a frame for  $L$  (see Section 2). Roughly speaking, well separability of a model  $\underline{K}$  refers to the fact that any two points of  $\underline{K}$  can be distinguished by a formula;  $\underline{K}$  is full if, for every point  $\alpha$  of  $\underline{K}$ , for every saturated set  $\Delta$  (i.e., a consistent set of formulas closed under INT-provability and disjunction) containing the formulas forced in  $\alpha$ , there is a point  $\beta \geq \alpha$  which forces exactly the formulas in  $\Delta$ . As pointed out in [10], in many cases the proof of canonicity of a logic  $L$  can be carried out using weaker properties than the properties (i) and (ii) mentioned in the definition. This suggests that we can refine the notion of canonicity, distinguishing some kinds of “subcanonicity”; thus, following [10], we introduce the stronger notions of *hypercanonicity* and *extensive canonicity* (see Section 3). This does not exhaust the possible cases and other subclasses may be introduced; for instance, the notions of *Df-persistence* and *R-persistence* investigated in literature (e.g., [2, 18]) fall within this classification; more precisely, Df-persistence is a stronger notion than hypercanonicity, R-persistence strengthens extensive canonicity (see Section 8). On the other hand, we are not interested in a such a detailed analysis; we think that the relevant gap is between the extensively canonical logics and the “simple” canonical logics which are not extensively canonical. For such logics, in the proof of canonicity the fullness hypothesis cannot be avoided; this means that the proof may be rather involved and strong mathematical principles must be used (see, for instance, the proof of Theorem 5.12 and the subsequent discussion).

In our systematic approach, we introduce some simple criteria for hypercanonicity, extensive canonicity, canonicity (Section 3) and strong completeness (Section 4) of intermediate propositional logics. These criteria are

especially useful when, in classifying logics, negative results are required; indeed, they turn out to be general (and easily manageable) tools to build “counterexamples”. Our approach is quite different from [10]: while in the quoted paper the authors use algebraic-categorical tools, we directly act on kripkean semantics, using techniques more inspired to the classical Model Theory. We point out that our canonicity criterion is formally similar to the one in [10], while our strong completeness criterion is more general than [10]; the hypercanonicity and extensive canonicity criteria are new.

The most interesting application regards the class of *logics in one variable*, that is, superintuitionistic logics having as extra axiom a formula containing only one propositional variable (see Section 5). In [10] the following significant result is proved: *all the intermediate logics with extra axioms in one variable, except four, are not strongly complete*<sup>1</sup>. Here we supplement this result, giving a more refined classification of this family of logics; moreover, we also take into account the family of logics in one variable having models with bounded depth. Finally, we give other original applications to *Medvedev logic MV* (Section 6, where it is proved that **MV** is not extensively canonical) and to the so called *logic of rhombuses RH* (Section 7, where the non canonicity of **RH** is shown).

For a more comprehensive exposition of the subject, the reader is referred to [8].

## 2. Preliminary definitions

As usual, a (*Kripke*) *frame* is a pair  $\underline{P} = \langle P, \leq \rangle$  consisting of a nonempty set  $P$  and a partial order  $\leq$  on  $P$ , i.e.,  $\underline{P}$  is a partially ordered set (*poset*). The elements of  $P$  are called the *points* of the frame  $\underline{P}$  and  $\alpha \leq \beta$  is read as “ $\beta$  is accessible from  $\alpha$ ” or “ $\alpha$  sees  $\beta$ ”. We write  $\alpha < \beta$  to mean that  $\alpha \leq \beta$  and  $\alpha \neq \beta$ ; we also use the notations  $\beta \geq \alpha$  and  $\beta > \alpha$  as a synonymous of  $\alpha \leq \beta$  and  $\alpha < \beta$  respectively. A *subframe* of  $\underline{P}$  is a frame  $\underline{P}' = \langle P', \leq' \rangle$  obtained by considering a subset  $P'$  of  $P$  and the restriction  $\leq'$  of  $\leq$  to  $P'$ ; the subframe is said to be a *generated subframe* iff  $P'$  is upward closed. If  $\alpha$  is a point of  $\underline{P}$ , the *cone*  $\underline{P}_\alpha$  of  $\underline{P}$  is the generated subframe of  $\underline{P}$  obtained

---

<sup>1</sup>The author has also proved a stronger result [9]: *all the intermediate logics with extra axioms in one variable, except eight, are not strongly  $\omega$ -complete*, where strong  $\omega$ -completeness is strong completeness relativized to languages generated by *finite* sets of propositional variables.

by considering  $\alpha$  and all the points accessible from  $\alpha$ .

A point  $\beta$  is an *immediate successor* of  $\alpha$  if  $\alpha < \beta$  and, for all points  $\gamma$  of  $\underline{P}$  such that  $\alpha \leq \gamma \leq \beta$ , we have either  $\gamma = \alpha$  or  $\gamma = \beta$ . A *final point* of a frame  $\underline{P} = \langle P, \leq \rangle$  is a maximal point of  $\underline{P}$ ;  $\text{Fin}(\alpha)$  denotes the set of all the final points accessible from  $\alpha$ . We say that  $\alpha$  has *depth*  $n$  (and we write  $\text{depth}(\alpha) = n$ ) if  $n$  is the maximum length of a chain of points starting from  $\alpha$  (namely, there is a sequence of  $n$  points of  $\underline{P}$   $\alpha_1 \equiv \alpha < \alpha_2 < \dots < \alpha_n$  and any other sequence of this kind contains at most  $n$  points). Clearly, a final point has depth 1. The depth of a frame  $\underline{P}$  is the maximum between the depths of the points of  $\underline{P}$ . With the notation  $\underline{P} = \langle P, \leq, \rho \rangle$ , we put into evidence the *root*  $\rho$  of  $\underline{P}$  (i.e.,  $\rho$  is the minimum point of  $\underline{P}$ ). In the sequel, we will assume to fix a *propositional language*  $\mathcal{L}_{\mathcal{V}}$ , containing the *propositional connectives*  $\wedge, \vee, \rightarrow, \neg$  and a numerable set of *propositional variables*  $\mathcal{V}$ . The *formulas* of  $\mathcal{L}_{\mathcal{V}}$  are defined in the usual way; given a formula  $A$ ,  $\text{Var}(A)$  denotes the (finite) set of propositional variables occurring in  $A$  and, if  $\text{Var}(A) \subseteq V$  (where  $V \subseteq \mathcal{V}$ ), we say that  $A$  is a  $V$ -formula. A *substitution*  $\sigma$  is a map from  $\mathcal{V}$  to the formulas of  $\mathcal{L}_{\mathcal{V}}$ ;  $\sigma A$  denotes the formula obtained by replacing every propositional variable  $p$  occurring in  $A$  with the formula  $\sigma p$ .

Let  $\underline{P} = \langle P, \leq \rangle$  be a frame; a *Kripke model*  $\underline{K} = \langle P, \leq, \Vdash \rangle$  is obtained by defining a *forcing relation*  $\Vdash$  between any point  $\alpha$  of  $\underline{P}$  and any propositional variable  $p$  of  $\mathcal{V}$ , in such a way that  $\alpha \Vdash p$  and  $\alpha \leq \beta$  imply  $\beta \Vdash p$ ; the forcing relation is extended to all the formulas of  $\mathcal{L}_{\mathcal{V}}$  in the usual way. When  $\underline{K} = \langle P, \leq, \Vdash \rangle$ , we say that  $\underline{K}$  is *based* on the frame  $\underline{P} = \langle P, \leq \rangle$  and that  $\underline{P}$  is the (underlying) frame of  $\underline{K}$ . Submodels, generated submodels and cones of models are defined similarly to subframes, generated subframes and cones of frames. Given a model  $\underline{K} = \langle P, \leq, \Vdash \rangle$  and  $\alpha \in P$ ,  $\Gamma_{\underline{K}}(\alpha)$  (or simply  $\Gamma(\alpha)$  if the context is clear) denotes the set of the formulas forced in  $\alpha$ . If  $V$  is a set of propositional variables,  $\Gamma_{\underline{K}}^V(\alpha)$  (or simply  $\Gamma^V(\alpha)$  if the context is clear) denotes the set of  $V$ -formulas forced in  $\alpha$ .

We say that a formula  $A$  is *valid* in  $\underline{K}$  (and we write  $\underline{K} \models A$ ) iff  $\alpha \Vdash A$  for all  $\alpha \in P$ ; a set of formulas  $\Delta$  is *valid* in  $\underline{K}$  (and we write  $\underline{K} \models \Delta$ ) iff  $\underline{K} \models A$  for every  $A \in \Delta$  (in this case we also say that  $\underline{K}$  is a model of  $\Delta$ ).

We say that a formula  $A$  is *valid* in a frame  $\underline{P}$  (and we write  $\underline{P} \models A$ ) iff  $\underline{K} \models A$  for every Kripke model  $\underline{K}$  based on  $\underline{P}$ ;  $\underline{P} \models \Delta$  iff  $\underline{P} \models A$  for every  $A \in \Delta$ .

Let  $\Gamma$  and  $\Delta$  be two sets of formulas and let  $\mathcal{F}$  be a class of frames. We

say that  $\Delta$  is a consequence of  $\Gamma$  w.r.t.  $\mathcal{F}$ , and we write  $\Gamma \models_{\mathcal{F}} \Delta$ , iff, for all models  $\underline{K} = \langle P, \leq, \Vdash \rangle$  based on the frames of  $\mathcal{F}$  and all  $\alpha \in P$ , it holds that:

$$\alpha \Vdash A \text{ for all } A \in \Gamma \implies \alpha \Vdash B \text{ for some } B \in \Delta.$$

We denote by **Int** and **Cl** the *propositional intuitionistic logic* and the *propositional classical logic* respectively. An *intermediate propositional logic*  $L$  in the language  $\mathcal{L}_{\mathcal{V}}$  is any set  $L$  of formulas of the language  $\mathcal{L}_{\mathcal{V}}$  such that **Int**  $\subseteq L \subseteq$  **Cl**,  $L$  is closed under *modus ponens* and  $L$  is closed under *substitutions* (i.e.,  $A \in L$  implies  $\sigma A \in L$ , for every substitution  $\sigma$ ). Given a set  $V$  of propositional variables (contained in the set  $\mathcal{V}$ ),  $L^V$  denotes the set of  $V$ -formulas of  $L$  (note that  $L^V$  satisfies all the properties of an intermediate logic with respect to the restricted language  $\mathcal{L}_V$ ). For any two sets of formulas  $\Gamma$  and  $\Delta$ , with  $\Gamma \vdash_L \Delta$  we mean that there are some formulas  $A_1, \dots, A_n$  in  $\Gamma$  and  $B_1, \dots, B_m$  in  $\Delta$  such that  $A_1 \wedge \dots \wedge A_n \rightarrow B_1 \vee \dots \vee B_m \in L$ ;  $\vdash_L A$  means  $A \in L$ .

In the sequel, we will adopt essentially two ways to define intermediate logics. Let  $\Delta$  be any set of formulas such that  $\Delta \subseteq$  **Cl**; then **Int** +  $\Delta$  denotes the intermediate logic  $L$  which coincides with the closure of the set of formulas **Int**  $\cup \Delta$  with respect to modus ponens and substitutions. The formulas in  $\Delta$  are called *additional* or *extra axioms* of  $L$  (over **Int**). If  $\Delta = \{A_1, \dots, A_n\}$ , we write also **Int** +  $A_1 + \dots + A_n$  instead of **Int** +  $\Delta$ . If a logic  $L$  can be represented as **Int** +  $\Delta$  with  $\Delta$  finite, we say that  $L$  is *finitely axiomatizable*. Given any two intermediate logics  $L_1$  and  $L_2$ ,  $L_1 + L_2$  denotes the union of  $L_1$  with  $L_2$ , which is the smallest intermediate logic including both  $L_1$  and  $L_2$ .

From a semantical viewpoint, we can define an intermediate logic starting from a nonempty class of frames  $\mathcal{F}$ . As a matter of fact, let us consider the set:

$$\mathcal{L}(\mathcal{F}) = \{A : \text{for all } \underline{P} = \langle P, \leq \rangle \in \mathcal{F}, \underline{P} \models A\}.$$

Then, it is well known that  $\mathcal{L}(\mathcal{F})$  is an intermediate propositional logic; we call it the *logic of*  $\mathcal{F}$ . Whenever  $L = \mathcal{L}(\mathcal{F})$ , the logic  $L$  is said to be *characterized* (or *described*) by the class of frames  $\mathcal{F}$ . If  $\underline{P} = \langle P, \leq \rangle$  is a frame for a logic  $L$ , then any proper generated subframe of  $\underline{P}$  is a frame for  $L$ ; in some cases also the converse holds. For instance, let us say that a

frame  $\underline{P} = \langle P, \leq, \rho \rangle$  has the *filter property* if, for every  $\alpha, \beta \in P$  s.t.  $\rho < \alpha$  and  $\rho < \beta$ , there is  $\gamma \in P$  such that  $\rho < \gamma < \alpha$  and  $\rho < \gamma < \beta$ . Then, the following property holds.

**Proposition 2.1.** *Let  $L$  be an intermediate logic, let  $\underline{P} = \langle P, \leq, \rho \rangle$  be a frame which has the filter property and suppose that every proper cone of  $\underline{P}$  is a frame for  $L$ . Then  $\underline{P}$  is a frame for  $L$ .*

Let  $\underline{P} = \langle P, \leq \rangle$  and  $\underline{P}' = \langle P', \leq' \rangle$  be any two frames; a *p-morphism* from  $\underline{P}$  onto  $\underline{P}'$  is a surjective map  $f : P \rightarrow P'$  such that:

- $f$  is order preserving.
- $f$  is *open*. This means: for every  $\alpha \in P$  and  $\beta' \in P'$ , if  $f(\alpha) \leq' \beta'$ , then there is  $\beta \in P$  such that  $\alpha \leq \beta$  and  $f(\beta) = \beta'$ .

Let  $\underline{K} = \langle P, \leq, \Vdash \rangle$  and  $\underline{K}' = \langle P', \leq', \Vdash' \rangle$  be any two Kripke models and let  $V$  be a set of propositional variables. We say that  $f$  is a *V p-morphism* from  $\underline{K}$  onto  $\underline{K}'$  iff:

- $f$  is a p-morphism from  $\underline{P}$  onto  $\underline{P}'$ ;
- for every  $p \in V$  and  $\alpha \in P$ ,  $\alpha \Vdash p$  iff  $f(\alpha) \Vdash' p$  (hence  $\Gamma_{\underline{K}}^V(\alpha) = \Gamma_{\underline{K}'}^V(f(\alpha))$ ).

A set of formulas  $\Delta$  is a *L-saturated set* (in the language  $\mathcal{L}_V$ ) if and only if:

- (i)  $\Delta$  is consistent (i.e., it is not the case that, for some formula  $A$ ,  $\Delta \vdash_L A$  and  $\Delta \vdash_L \neg A$ );
- (ii)  $\Delta \vdash_L A$  (where  $A \in \mathcal{L}_V$ ) implies  $A \in \Delta$ ;
- (iii)  $A \vee B \in \Delta$  implies either  $A \in \Delta$  or  $B \in \Delta$ .

If  $L$  is omitted, it is understood that  $\Delta$  is an **Int**-saturated set. The definition of *L, V-saturated set* is the relativisation of the definition of saturated set with respect to  $V$ -formulas; namely, we take into account only the formulas of the language  $\mathcal{L}_V$ . Note that the set of  $V$ -formulas of a  $L$ -saturated set  $\Delta$  is a  $L, V$ -saturated set. We remark that, given a model  $\underline{K}$  and a point  $\alpha$  of  $\underline{K}$ ,  $\Gamma_{\underline{K}}(\alpha)$  is a saturated set and  $\Gamma_{\underline{K}}^V(\alpha)$  is a  $V$ -saturated set. We say that a saturated set  $\Delta$  is *realized* in  $\underline{K}$  if  $\Delta = \Gamma_{\underline{K}}(\alpha)$  for some point  $\alpha$  of  $\underline{K}$  (similar definition for  $V$ -saturated sets). We now recall an important lemma about saturated sets (see [3]).

**Lemma 2.2 (Inclusion-exclusion Lemma).** *Let  $L$  be an intermediate logic and let  $\Gamma$  and  $\Delta$  be two sets of formulas such that  $\Gamma \not\vdash_L \Delta$ . Then there is a  $L$ -saturated set  $\Gamma^*$  such that  $\Gamma \subseteq \Gamma^*$  and  $\Gamma^* \cap \Delta = \emptyset$ .*

We introduce some natural definitions related to the separability of the points of a Kripke model by means of formulas (see also [10]).

**Definition 2.3.** Let  $\underline{K} = \langle P, \leq, \Vdash \rangle$  be any Kripke model and let  $V$  be a set of propositional variables.

- (a)  $\underline{K}$  is (simply) separable iff, for every  $\alpha, \beta \in P$ ,  $\Gamma_{\underline{K}}(\alpha) = \Gamma_{\underline{K}}(\beta)$  implies  $\alpha = \beta$ .
- (b)  $\underline{K}$  is (simply)  $V$ -separable iff, for every  $\alpha, \beta \in P$ ,  $\Gamma_{\underline{K}}^V(\alpha) = \Gamma_{\underline{K}}^V(\beta)$  implies  $\alpha = \beta$ .
- (c)  $\underline{K}$  is well separable iff, for every  $\alpha, \beta \in P$ ,  $\Gamma_{\underline{K}}(\alpha) \subseteq \Gamma_{\underline{K}}(\beta)$  implies  $\alpha \leq \beta$ .
- (d)  $\underline{K}$  is well  $V$ -separable iff, for every  $\alpha, \beta \in P$ ,  $\Gamma_{\underline{K}}^V(\alpha) \subseteq \Gamma_{\underline{K}}^V(\beta)$  implies  $\alpha \leq \beta$ .
- (e)  $\underline{K}$  is full iff, for every  $\alpha \in P$  and every saturated set  $\Delta$  such that  $\Gamma_{\underline{K}}(\alpha) \subseteq \Delta$ , there is  $\beta \geq \alpha$  such that  $\Gamma_{\underline{K}}(\beta) = \Delta$ .
- (f)  $\underline{K}$  is  $V$ -full iff, for every  $\alpha \in P$  and every  $V$ -saturated set  $\Delta^V$  such that  $\Gamma_{\underline{K}}^V(\alpha) \subseteq \Delta^V$ , there is  $\beta \geq \alpha$  such that  $\Gamma_{\underline{K}}^V(\beta) = \Delta^V$ .

We remark that in literature (for instance in [3]) separable models are also called *differentiated* or *distinguishable*, well separable models are called *refined* models, and full separable models correspond to *descriptive general frames*. It is immediate to see that models which are both  $V$ -separable and  $V$ -full are also well  $V$ -separable; similarly, separable and full models are also well separable.

We conclude by reporting some useful properties of finite Kripke models (i.e., Kripke models having finitely many points).

**Lemma 2.4.** *Let  $\underline{K} = \langle P, \leq, \Vdash \rangle$  be a finite model, let  $V$  be a set of propositional variables, and let  $\underline{K}' = \langle P', \leq', \Vdash' \rangle$  be a Kripke model (possibly  $\underline{K}' = \underline{K}$ ); let  $\alpha \in P$  and  $\alpha' \in P'$  be such that  $\Gamma_{\underline{K}}^V(\alpha) = \Gamma_{\underline{K}'}^V(\alpha')$ , and let  $\Delta^V$  be a  $V$ -saturated set such that  $\Gamma_{\underline{K}'}^V(\alpha') \subseteq \Delta^V$ . Then there is  $\beta' \in P'$  such that  $\alpha' \leq' \beta'$  and  $\Gamma_{\underline{K}'}^V(\beta') = \Delta^V$ .*

**Proof.** By the finiteness of  $\underline{K}$ , we can find a finite set of  $V$ -formulas  $\Sigma$  such that, for every  $V$ -formula  $H$ , there is  $A \in \Sigma$  such that  $\alpha \Vdash A \leftrightarrow H$ . Let us assume that  $\Sigma = \{A_1, \dots, A_m, B_1, \dots, B_l\}$ , where  $A_1 \in \Delta^V, \dots, A_m \in \Delta^V, B_1 \notin \Delta^V, \dots, B_l \notin \Delta^V$ . By definition of  $V$ -saturated set, it follows that the  $V$ -formula  $Z = A_1 \wedge \dots \wedge A_m \rightarrow B_1 \vee \dots \vee B_l$  does not belong to  $\Delta^V$ , hence  $\alpha' \not\Vdash Z$ . This implies that there is  $\beta' \in P'$  such that  $\alpha' \leq' \beta'$ ,  $\beta' \Vdash A_1, \dots, \beta' \Vdash A_m$  and  $\beta' \not\Vdash B_1, \dots, \beta' \not\Vdash B_l$ . We show that  $\Gamma_{\underline{K}'}^V(\beta') = \Delta^V$ . Let  $H \in \Delta^V$ ; then, for some  $1 \leq i \leq m$ ,  $\alpha \Vdash H \leftrightarrow A_i$ , hence  $\alpha' \Vdash H \leftrightarrow A_i$ . Since  $\beta' \Vdash A_i$ , it follows that  $\beta' \Vdash H$ . Likewise we can show that  $\Gamma_{\underline{K}'}^V(\beta') \subseteq \Delta^V$ ; thus  $\Gamma_{\underline{K}'}^V(\beta') = \Delta^V$ . ■

Taking  $\underline{K} = \underline{K}'$ , it is immediately proved that:

**Proposition 2.5.** *Let  $\underline{K} = \langle P, \leq, \Vdash \rangle$  be a finite model and let  $V$  be any set of propositional variables. Then  $\underline{K}$  is  $V$ -full.*

In particular, taking as  $V$  the set of all the propositional variables, we also get that  $\underline{K}$  is full; this implies that, if in addition  $\underline{K}$  is separable ( $V$ -separable), then  $\underline{K}$  is well separable (well  $V$ -separable). Taking into account all these facts, it follows that:

**Proposition 2.6.** *Let  $\underline{K} = \langle P, \leq, \rho, \Vdash \rangle$  be a finite  $V$ -separable model (where  $V$  is any set of propositional variables) and let  $\underline{K}' = \langle P', \leq', \rho', \Vdash' \rangle$  be any Kripke model such that  $\Gamma_{\underline{K}}^V(\rho) = \Gamma_{\underline{K}'}^V(\rho')$ . Let  $h$  be a map from the points of  $\underline{K}'$  to the points of  $\underline{K}$  such that  $h(\alpha') = \alpha$  if and only if  $\Gamma_{\underline{K}'}^V(\alpha') = \Gamma_{\underline{K}}^V(\alpha)$ . Then  $h$  is a  $V$   $p$ -morphism from  $\underline{K}'$  onto  $\underline{K}$ .*

Finally, we recall the following well-known property of finite models:

**Proposition 2.7.** *Let  $L$  be an intermediate logic and let  $\underline{K} = \langle P, \leq, \Vdash \rangle$  be a finite separable model of  $L$ . Then  $\underline{K}$  is based on a frame for  $L$ .*

### 3. Canonicity

We introduce the main notions of the paper, which refer to the relationships between the syntactical and the semantical aspects of a logic. Let  $L$  be any intermediate propositional logic; a frame  $\underline{P} = \langle P, \leq \rangle$  is said to be a *frame for  $L$*  if  $\underline{P} \models L$ ;  $\text{Fr}(L)$  denotes the (nonempty) class of the frames for  $L$ . From the definition, it immediately follows that:



- $L \subseteq \mathcal{L}(\text{Fr}(L))$ ;
- $\Gamma \vdash_L \Delta$  implies  $\Gamma \models_{\text{Fr}(L)} \Delta$ , for every sets of formulas  $\Gamma$  and  $\Delta$ .

The converse need not be true, so the following definitions of *completeness* are justified.

**Definition 3.1.** Let  $L$  be any intermediate logic. Then:

- (a)  $L$  is *complete* (or *has Kripke semantics*) iff  $L = \mathcal{L}(\text{Fr}(L))$ .
- (b)  $L$  is *strongly complete* iff, for any two sets of formulas  $\Gamma$  and  $\Delta$ , it holds that:

$$\Gamma \vdash_L \Delta \iff \Gamma \models_{\text{Fr}(L)} \Delta.$$

We remark that, if we impose  $\Delta$  and  $\Gamma$  to be finite, (a) and (b) are equivalent. An equivalent definition of strong completeness is stated in the next proposition.

**Proposition 3.2.** *Let  $L$  be any intermediate logic;  $L$  is strongly complete if and only if every  $L$ -saturated set  $\Delta$  is realized in some (non necessarily separable) Kripke model based on a frame for  $L$ .*

In our investigation about Kripke completeness, there is no use considering the class of all frames. Let us say that a frame  $\underline{P} = \langle P, \leq \rangle$  (a model  $\underline{K} = \langle P, \leq, \Vdash \rangle$ ) has *enough final points* iff, for every  $\alpha \in P$ ,  $\text{Fin}(\alpha) \neq \emptyset$ . We point out that a full model  $\underline{K}$  always has enough final points (for  $\alpha \in P$ , take, by Zorn Lemma, a maximal saturated set  $\Phi$  s.t.  $\Gamma_{\underline{K}}(\alpha) \subseteq \Phi$ ; then, the point  $\beta \in P$  such that  $\alpha \leq \beta$  and  $\Gamma_{\underline{K}}(\beta) = \Phi$  is final). In [6] the following fact is proved:

**Proposition 3.3.** *Let  $\mathcal{F}$  be any class of frames. Then there is a class  $\mathcal{F}^{\text{Fin}}$ , containing only frames with enough final points, such that  $\mathcal{L}(\mathcal{F}) = \mathcal{L}(\mathcal{F}^{\text{Fin}})$ .*

It follows that a logic  $L$  has Kripke semantics iff  $L$  is characterized by some nonempty class of frames with enough final points. Therefore, there is no loss of generality if we assume:

**Assumption 3.4.** *All Kripke frames (models) we deal with have enough final points.*

Notice that the standard tools used in proving the completeness of a logic (via canonicity, by means of filtration techniques) actually refer to classes of frames with enough final points.

We can introduce the notion of canonicity as follows (see also [10]).

**Definition 3.5 (Canonicity).** *A logic  $L$  is said to be canonical if and only if every separable and full model of  $L$  is based on a frame for  $L$ .*

As an immediate consequence of the definition, a canonical logic is strongly complete. As usual, the *canonical model*  $\underline{\mathcal{C}}_L = \langle P_L, \leq, \Vdash \rangle$  of a logic  $L$  is the Kripke model such that:

- $P_L$  is the set of all the  $L$ -saturated sets;
- $\leq$  coincides with the inclusion between sets;
- for every propositional variable  $p$  and every  $\Delta \in P_L$ ,  $\Delta \Vdash p$  iff  $p \in \Delta$ .

Using the Inclusion-exclusion Lemma, one can prove that the last condition holds for all formulas. Clearly,  $\mathcal{C}_L$  is a full model of  $L$ , even better, it contains (up to isomorphisms), as generated submodels, all the full models of  $L$ . Thus, denoting with  $\underline{P}_L$  the frame of  $\mathcal{C}_L$ , we can state that  $L$  is canonical iff  $\underline{P}_L$  is a frame for  $L$ , which corresponds to the standard definition of canonicity. By the above definitions, it immediately follows that:

$$\text{canonicity} \implies \text{strong completeness} \implies \text{(Kripke) completeness}$$

We stress that the converse of both implications does not hold. As a matter of fact, we will see infinitely many examples of complete logics which are not strongly complete; examples of strongly complete logics which are not canonical can be found in [20]. Finally, we recall two important results about canonicity (see [3]).

**Theorem 3.6.** *If a logic  $L$  is axiomatized by disjunction free axioms, then  $L$  is canonical.*

**Theorem 3.7 (Fine, van Benthem).** *If a logic  $L$  is characterized by a first-order definable class of frames, then  $L$  is canonical.*

In proofs of canonicity, not all the properties quoted in Definition 3.5 are used. According to [10], we propose a finer classification of canonical logics based on the possibility of weakening the requirements to be satisfied by the models  $\underline{K}$  without affecting canonicity.

**Definition 3.8.** Let  $L$  be any intermediate logic.

- (a)  $L$  is *hypercanonical* iff the underlying frame of any separable Kripke model (with enough final points) of  $L$  is a frame for  $L$ .
- (b)  $L$  is *extensively canonical* iff the underlying frame of any well separable Kripke model (with enough final points) of  $L$  is a frame for  $L$ .

We postpone to Section 8 the definition of other classes of subcanonicity.

Now, we introduce the key notion of chain of frames. Let, for every  $n \geq 1$ ,  $\underline{P}_n = \langle P_n, \leq_n \rangle$  be a frame; we say that  $\mathcal{C} = \{\underline{P}_n, f_n\}_{n \geq 1}$  is a *chain of frames* if, for every  $n \geq 1$ ,  $f_n$  is a p-morphism from  $\underline{P}_{n+1}$  onto  $\underline{P}_n$ . We now define four different notions of limit of a chain. Let  $\underline{P} = \langle P, \leq \rangle$  be any frame and let, for each  $n \geq 1$ ,  $h_n$  be a p-morphism from  $\underline{P}$  onto  $\underline{P}_n$ .

- (1) We say that  $\underline{P}$  is a *weak limit* of  $\mathcal{C}$  with projections  $\{h_n\}_{n \geq 1}$  iff the p-morphisms  $h_n$  commute with the p-morphisms  $f_n$  (i.e.,  $h_n = f_n \circ h_{n+1}$ ).

This property can be represented by the commutative diagram in Figure 1. We call  $h_n$  the *projection* of  $\underline{P}$  onto  $\underline{P}_n$ .

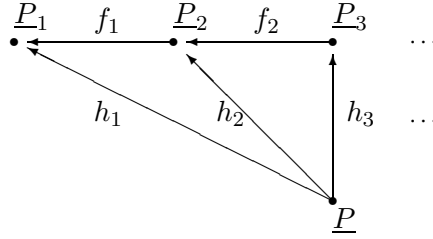

Figure 1: Diagram of a chain of frames

- (2) We say that  $\underline{P}$  is a *separable weak limit* of  $\mathcal{C}$  with projections  $\{h_n\}_{n \geq 1}$  iff:
  - $\underline{P}$  is a weak limit of  $\mathcal{C}$  with projections  $\{h_n\}_{n \geq 1}$ ;
  - for every  $\alpha, \beta \in P$ , if, for all  $n \geq 1$ ,  $h_n(\alpha) = h_n(\beta)$ , then  $\alpha = \beta$ .
- (3) We say that  $\underline{P}$  is a *well separable weak limit* of  $\mathcal{C}$  with projections  $\{h_n\}_{n \geq 1}$  iff:
  - $\underline{P}$  is a weak limit of  $\mathcal{C}$  with projections  $\{h_n\}_{n \geq 1}$ ;
  - for every  $\alpha, \beta \in P$ , if, for all  $n \geq 1$ ,  $h_n(\alpha) \leq_n h_n(\beta)$ , then  $\alpha \leq \beta$ .

- (4) We say that  $\underline{P}$  is a *limit* of  $\mathcal{C}$  with projections  $\{h_n\}_{n \geq 1}$  iff:
- $\underline{P}$  is a well separable limit of  $\mathcal{C}$  with projections  $\{h_n\}_{n \geq 1}$ ;
  - for every  $\alpha_1 \in P_1, \dots, \alpha_n \in P_n \dots$ , if, for all  $n \geq 1$ ,  $\alpha_n = f_n(\alpha_{n+1})$ , then there is  $\alpha \in P$  such that  $h_n(\alpha) = \alpha_n$  for every  $n \geq 1$ .

Clearly, each definition is a proper refinement of the previous one; moreover, the limit of a chain is uniquely determined (up to isomorphisms), as proved in the next proposition.

**Proposition 3.9.** *Let  $\mathcal{C} = \{\underline{P}_n, f_n\}_{n \geq 1}$  be a chain of frames  $\underline{P}_n = \langle P_n, \leq_n \rangle$ . Then  $\mathcal{C}$  has one and only one limit (up to isomorphisms).*

**Proof.** To prove the existence of at least one limit, let us define the frame  $\underline{P}^* = \langle P^*, \leq^* \rangle$  as follows:

- $P^* = \{\alpha^* = \langle \alpha_1, \alpha_2, \dots \rangle : \text{for every } n \geq 1, \alpha_n \in P_n \text{ and } \alpha_n = f_n(\alpha_{n+1})\}$ ;
- $\langle \alpha_1, \alpha_2, \dots \rangle \leq^* \langle \beta_1, \beta_2, \dots \rangle$  iff, for every  $n \geq 1$ ,  $\alpha_n \leq_n \beta_n$ .

It is easy to see that  $\underline{P}^*$  is a limit of  $\mathcal{C}$  having, as projections, the maps  $h_n^*$  such that  $h_n^*(\langle \alpha_1, \dots, \alpha_n, \dots \rangle) = \alpha_n$ . Suppose now that  $\underline{P}'$  and  $\underline{P}''$  are two distinct limits of  $\mathcal{C}$  with projections  $\{h'_n\}_{n \geq 1}$  and  $\{h''_n\}_{n \geq 1}$  respectively. Let us define a map  $g$  from  $\underline{P}'$  to  $\underline{P}''$  in the following way:

$$g(\alpha') = \alpha'' \text{ iff } h'_n(\alpha') = h''_n(\alpha'') \text{ for every } n \geq 1 .$$

Then  $g$  is an isomorphism between  $\underline{P}'$  and  $\underline{P}''$ , and this completes the proof. ■

Hereafter we assume that the limit of a chain is defined as in the proof of the previous proposition. Now, we pass to define a chain of Kripke models, which is a natural generalization of the chain of frames. Let  $\mathcal{C} = \{\underline{P}_n, f_n\}_{n \geq 1}$  be a chain of frames and let  $V_1 \subseteq V_2 \subseteq \dots \subseteq V_n \dots$  be a sequence of sets of propositional variables such that  $\bigcup_{n \geq 1} V_n$  coincides with the set of all the variables of the language. Then  $\mathcal{C}_K = \{\underline{K}_n, V_n, f_n\}_{n \geq 1}$  is a *chain of models* if, for every  $n \geq 1$ , it holds that:

- $\underline{K}_n = \langle P_n, \leq_n, \Vdash_n \rangle$  is a  $V_n$ -separable model based on the frame  $\underline{P}_n$ ;
- $f_n$  is a  $V_n$  p-morphism from  $\underline{K}_{n+1}$  onto  $\underline{K}_n$ .

The latter condition implies that, for every  $\alpha \in P_{n+1}$ ,

$$\Gamma_{\underline{K}_{n+1}}^{V_n}(\alpha) = \Gamma_{\underline{K}_n}^{V_n}(f_n(\alpha));$$

this means that, passing from  $\alpha' \in P_n$  to any preimage of  $\alpha'$  with respect to  $f_n$ , the forcing of the  $V_n$ -formulas does not change. The chain of frames associated with  $\mathcal{C}_K$  is the chain  $\mathcal{C} = \{\underline{P}_n, f_n\}_{n \geq 1}$ , where  $\underline{P}_n$  is the frame of  $\underline{K}_n$ . We can extend the notions of limit of a chain of frames to the case of chains of models. Let  $\mathcal{C}_K = \{\underline{K}_n, V_n, f_n\}_{n \geq 1}$  be a chain of models, let  $\mathcal{C}$  be the chain of frames associated with  $\mathcal{C}_K$ , let  $\underline{K} = \langle P, \leq, \Vdash \rangle$  be any Kripke model and let  $\underline{P} = \langle P, \leq \rangle$ .

- (1) We say that  $\underline{K}$  is a *weak limit* of  $\mathcal{C}_K$  with projections  $\{h_n\}_{n \geq 1}$  iff:
  - $\underline{P}$  is a weak limit of  $\mathcal{C}$  with projections  $\{h_n\}_{n \geq 1}$ ;
  - $h_n$  is a  $V_n$  p-morphism from  $\underline{K}$  onto  $\underline{K}_n$ .
- (2) We say that  $\underline{K}$  is a *separable weak limit* of  $\mathcal{C}_K$  with projections  $\{h_n\}_{n \geq 1}$  iff:
  - $\underline{P}$  is a separable weak limit of  $\mathcal{C}$  with projections  $\{h_n\}_{n \geq 1}$ ;
  - $h_n$  is a  $V_n$  p-morphism from  $\underline{K}$  onto  $\underline{K}_n$ .
- (3) We say that  $\underline{K}$  is a *well separable weak limit* of  $\mathcal{C}_K$  with projections  $\{h_n\}_{n \geq 1}$  iff:
  - $\underline{P}$  is a well separable weak limit of  $\mathcal{C}$  with projections  $\{h_n\}_{n \geq 1}$ ;
  - $h_n$  is a  $V_n$  p-morphism from  $\underline{K}$  onto  $\underline{K}_n$ .
- (4) We say that  $\underline{K}$  is a *limit* of  $\mathcal{C}_K$  with projections  $\{h_n\}_{n \geq 1}$  iff:
  - $\underline{P}$  is a limit of  $\mathcal{C}$ ;
  - $h_n$  is a  $V_n$  p-morphism from  $\underline{K}$  onto  $\underline{K}_n$ .

**Proposition 3.10.** *Let  $\mathcal{C}_K = \{\underline{K}_n, V_n, f_n\}_{n \geq 1}$  be a chain of models and let  $\underline{K} = \langle P, \leq, \Vdash \rangle$  be a weak limit of  $\mathcal{C}_K$  having projections  $\{h_n\}_{n \geq 1}$ . Then, for every  $\alpha \in P$ , it holds that:*

- (i)  $\Gamma_{\underline{K}}^{V_n}(\alpha) = \Gamma_{\underline{K}_n}^{V_n}(h_n(\alpha))$ , for every  $n \geq 1$ .
- (ii)  $\Gamma_{\underline{K}}(\alpha) = \bigcup_{n \geq 1} \Gamma_{\underline{K}_n}^{V_n}(h_n(\alpha))$ .

Thus, the model  $\underline{K}_n$  of a chain  $\mathcal{C}_K$  can be viewed as a sort of approximation, up to the  $V_n$ -formulas, of any weak limit of  $\mathcal{C}_K$ . Let  $\mathcal{C}_K$  be a chain of models and let  $\underline{P} = \langle P, \leq \rangle$  be a weak limit with projections  $\{h_n\}_{n \geq 1}$  of the chain of frames  $\mathcal{C}$  associated with  $\mathcal{C}_K$ ; then the weak limit  $\underline{K} = \langle P, \leq, \Vdash \rangle$  of  $\mathcal{C}_K$  based on  $\underline{P}$  and having the same projections  $\{h_n\}_{n \geq 1}$  is uniquely determined by the following condition:

$$\text{for every } p \in V_n, \alpha \Vdash p \text{ iff } h_n(\alpha) \Vdash_n p$$

One can easily check that the above condition actually defines a forcing relation; in particular, the limit of a chain of models is unique up to isomorphisms. Note that, choosing different projections, we obtain different forcing relations. We now study the properties of the models of  $\mathcal{C}_K$  which are preserved in weak limits.

**Proposition 3.11.** *Let  $L$  be an intermediate logic and let  $\mathcal{C}_K = \{\underline{K}_n, V_n, f_n\}_{n \geq 1}$  be a chain of models  $\underline{K}_n$  of  $L$ .*

(i) *Every weak limit of  $\mathcal{C}_K$  is a model of  $L$ .*

(ii) *Every separable weak limit of  $\mathcal{C}_K$  is a separable model of  $L$ .*

(iii) *If, for every  $n \geq 1$ ,  $\underline{K}_n$  is well  $V_n$ -separable, then every well separable weak limit of  $\mathcal{C}_K$  is a well separable model of  $L$ .*

(iv) *If, for every  $n \geq 1$ ,  $\underline{K}_n$  is  $V_n$ -full, then the limit  $\underline{K}^* = \langle P^*, \leq^*, \Vdash^* \rangle$  of  $\mathcal{C}_K$  is a separable and full model of  $L$ .*

**Proof.** (i) Let  $\underline{K} = \langle P, \leq, \Vdash \rangle$  be a weak limit of  $\mathcal{C}_K$  having projections  $\{h_n\}_{n \geq 1}$ . Let us take any formula  $A$  of  $L$  and any point  $\alpha$  of  $\underline{P}$ . Let  $n \geq 1$  be such that  $\text{Var}(A) \subseteq V_n$ ; since  $h_n(\alpha) \Vdash_n A$  and  $\Gamma_{\underline{K}}^{V_n}(\alpha) = \Gamma_{\underline{K}_n}^{V_n}(h_n(\alpha))$ , it follows that  $\alpha \Vdash A$ , hence  $\underline{K}$  is a model of  $L$ .

(ii) Let  $\underline{K} = \langle P, \leq, \Vdash \rangle$  be a separable weak limit of  $\mathcal{C}_K$  having projections  $\{h_n\}_{n \geq 1}$ . By (i)  $\underline{K}$  is a model of  $L$ . To prove the separability, let  $\alpha, \beta \in P$  be such that  $\Gamma_{\underline{K}}(\alpha) = \Gamma_{\underline{K}}(\beta)$ . Then, for every  $n \geq 1$ ,  $\Gamma_{\underline{K}}^{V_n}(\alpha) = \Gamma_{\underline{K}}^{V_n}(\beta)$ , hence  $\Gamma_{\underline{K}_n}^{V_n}(h_n(\alpha)) = \Gamma_{\underline{K}_n}^{V_n}(h_n(\beta))$ . Since, by definition of  $\mathcal{C}_K$ ,  $\underline{K}_n$  is  $V_n$ -separable, we have that  $h_n(\alpha) = h_n(\beta)$  for every  $n \geq 1$ ; by definition of separable weak limit, it follows that  $\alpha = \beta$ .

(iii) It is proved as (ii).

(iv) By (ii)  $\underline{K}^*$  is a separable model of  $L$ . To prove the fullness, let  $\alpha^* = \langle \alpha_1, \alpha_2, \dots \rangle$  be a point of  $\underline{K}^*$  and let  $\Delta$  be any saturated set such that  $\Gamma_{\underline{K}^*}(\alpha^*) \subseteq \Delta$ . Let, for every  $n \geq 1$ ,  $\Delta_n$  be the set of all the  $V_n$ -formulas of  $\Delta$ . Then, for every  $n \geq 1$ ,  $\Gamma_{\underline{K}^*}^{V_n}(\alpha^*) \subseteq \Delta_n$ , that is  $\Gamma_{\underline{K}_n}^{V_n}(\alpha_n) \subseteq \Delta_n$ . Since  $\Delta_n$  is a  $V_n$ -saturated set and  $\underline{K}_n$  is  $V_n$ -full, there is  $\beta_n \in P_n$  such that  $\alpha_n \leq_n \beta_n$  and  $\Gamma_{\underline{K}_n}^{V_n}(\beta_n) = \Delta_n$ ; moreover, since  $\Gamma_{\underline{K}_{n+1}}^{V_n}(\beta_{n+1}) = \Delta_n = \Gamma_{\underline{K}_n}^{V_n}(\beta_n)$  and  $\underline{K}_n$  is  $V_n$ -separable, it holds that  $\beta_n = f_n(\beta_{n+1})$ . Therefore,  $\beta^* = \langle \beta_1, \dots, \beta_n, \dots \rangle$  is a point of  $\underline{P}^*$  such that  $\alpha^* \leq^* \beta^*$ . We have:

$$\Gamma_{\underline{K}^*}(\beta^*) = \bigcup_{n \geq 1} \Gamma_{\underline{K}_n}^{V_n}(\beta_n) = \bigcup_{n \geq 1} \Delta_n = \Delta$$

and this proves the fullness of  $\underline{K}^*$ . ■

Note that (iv) can be used to build “big” full models. Indeed, when we are concerned with finite models, no problems arise, since finite models are also full. On the other hand, when we deal with an infinite model  $\underline{K} = \langle P, \leq, \rho, \Vdash \rangle$ , it is not trivial to check that  $\underline{K}$  contains points in correspondence of all the saturated sets containing  $\Gamma_{\underline{K}}(\rho)$ . Point (iv) of the previous proposition allows us to get over the difficulty, at least when the full model  $\underline{K}$  can be approximated by means of finite models  $\underline{K}_n$ . To complete the picture, we point out that weak limits (and also limits) do not preserve, in general, the *first-order* properties valid in all the frames of a chain, as we will see later.

Now we formulate some criteria for hypercanonicity, extensive canonicity and canonicity respectively.

**Theorem 3.12 (Hypercanonicity Criterion).** *Let  $L$  be an hypercanonical logic of and let  $\mathcal{C} = \{\underline{P}_n, f_n\}_{n \geq 1}$  be a chain of frames  $\underline{P}_n = \langle P_n, \leq_n \rangle$  for  $L$  such that  $P_n$  is countable. Then every separable weak limit of  $\mathcal{C}$  is a frame for  $L$ .*

**Proof.** We can define a chain of models  $\mathcal{C}_K = \{\underline{K}_n, V_n, f_n\}_{n \geq 1}$  where  $\underline{K}_n$  is based on  $\underline{P}_n$  and  $\underline{K}_n$  is  $V_n$ -separable (or even well  $V_n$ -separable). Indeed, since the frames involved are countable, we can choose an increasing sequence of countable sets  $V_n$  (contained in the countable set of all the variables of the language) such that any two points of  $\underline{P}_n$  are (well) separated by some propositional variable of  $V_n$ . Moreover, since  $\underline{P}_n$  is a frame for  $L$ ,  $\underline{K}_n$  is a model of  $L$ . Let  $\underline{P}$  be a separable weak limit of  $\mathcal{C}$  having projections  $\{h_n\}_{n \geq 1}$  and let  $\underline{K}$  be the separable weak limit model of  $\mathcal{C}_K$  based on  $\underline{P}$  and having the same projections. By Proposition 3.11(ii),  $\underline{K}$  is a separable model of  $L$ ; by the hypercanonicity of  $L$ , we can conclude that  $\underline{P}$  is a frame for  $L$ . ■

In a similar way, using Proposition 3.11(iii), one can prove:

**Theorem 3.13 (Extensive Canonicity Criterion).** *Let  $L$  be an extensive canonical logic and let  $\mathcal{C} = \{\underline{P}_n, f_n\}_{n \geq 1}$  be a chain of frames  $\underline{P}_n = \langle P_n, \leq_n \rangle$  for  $L$  such that  $P_n$  is countable. Then every well separable weak limit of  $\mathcal{C}$  is a frame for  $L$ .*

We now state the Canonicity Criterion, which essentially coincides with the formulation in [10].

**Theorem 3.14 (Canonicity Criterion).** *Let  $L$  be a canonical logic and let  $\mathcal{C} = \{\underline{P}_n, f_n\}_{n \geq 1}$  be a chain of finite frames  $\underline{P}_n = \langle P_n, \leq_n \rangle$  for  $L$ . Then the limit of  $\mathcal{C}$  is a frame for  $L$ .*

**Proof.** Let us define a chain of models  $\mathcal{C}_K = \{\underline{K}_n, V_n, f_n\}_{n \geq 1}$  where  $\underline{K}_n$  is a  $V_n$ -separable model based on  $\underline{P}_n$  (note that we only need an increasing sequence of finite sets  $V_n$ ). Since  $\underline{P}_n$  is a finite frame for  $L$ , it follows that  $\underline{K}_n$  is also a  $V_n$ -full model of  $L$ . By Proposition 3.11(iv), the limit  $\underline{K}^*$  of  $\mathcal{C}_K$  is a separable and full model of  $L$ ; since  $L$  is canonical, the frame  $\underline{P}^*$  of  $\underline{K}^*$  (that is, the limit of  $\mathcal{C}$ ) is a frame for  $L$ . ■

We remark that the limit  $\underline{P}^*$  in the proof of the Canonicity Criterion is actually a generated subframe of the frame of the canonical model of  $L$ . We also stress that it is not immediate to extend the Canonicity Criterion to chains of countable frames; to do this, we have to give suitable conditions on the frame  $\underline{P}_n$  in order to define a full model  $\underline{K}_n$  on  $\underline{P}_n$ .

#### 4. Strong completeness

We pass to the analysis of strong completeness. As the definition suggests, we have to consider *all* the models which realize any  $L$ -saturated set  $\Delta$ . This requires a deeper study of the weak limits of a chain and of the relations between weak limits and the limit, which is, roughly speaking, the “biggest” model of  $\Delta$ . In the following proposition we show that, in some cases, we can completely characterize all the (non necessarily separable) models of  $\Delta$ .

**Proposition 4.1.** *Let  $\mathcal{C}_K = \{\underline{K}_n, V_n, f_n\}_{n \geq 1}$  be a chain of finite models  $\underline{K}_n = \langle P_n, \leq_n, \rho_n, \Vdash_n \rangle$ , let  $\Delta = \bigcup_{n \geq 1} \Gamma_{\underline{K}_n}^{V_n}(\rho_n)$  and let  $\underline{K} = \langle P, \leq, \rho, \Vdash \rangle$  be any Kripke model. Then,  $\Gamma_{\underline{K}}(\rho) = \Delta$  if and only if  $\underline{K}$  is a weak limit of  $\mathcal{C}_K$ .*

**Proof.** The “if” part corresponds to Point (ii) of Proposition 3.10. Suppose now that  $\Gamma_{\underline{K}}(\rho) = \Delta$  and let us define, for each  $n \geq 1$ , a map  $h_n$  from the points of  $\underline{K}$  to the points of  $\underline{K}_n$  in the following way:

$$h_n(\alpha) = \alpha' \quad \text{iff} \quad \Gamma_{\underline{K}}^{V_n}(\alpha) = \Gamma_{\underline{K}_n}^{V_n}(\alpha').$$

Since, for each  $n \geq 1$ ,  $\Gamma_{\underline{K}}^{V_n}(\rho) = \Gamma_{\underline{K}_n}^{V_n}(\rho_n)$  and  $\underline{K}_n$  is a finite  $V_n$ -separable model, we can apply Proposition 2.6 and claim that  $h_n$  is a  $V_n$  p-morphism



from  $\underline{K}$  onto  $\underline{K}_n$ . Moreover, by definition of  $\mathcal{C}_K$  the maps  $h_n$  commute with the maps  $f_n$ ; this means that  $\underline{K}$  is a weak limit of  $\mathcal{C}_K$  with projections  $\{h_n\}_{n \geq 1}$ . ■

**Theorem 4.2 (Necessary Condition for Strong Completeness).**

Let  $L$  be a strongly complete logic and let  $\mathcal{C} = \{\underline{P}_n, f_n\}_{n \geq 1}$  be a chain of finite frames  $\underline{P}_n = \langle P_n, \leq_n, \rho_n \rangle$  for  $L$ . Then there is a weak limit  $\underline{P} = \langle P, \leq, \rho \rangle$  of  $\mathcal{C}$  which is a frame for  $L$ .

**Proof.** As in the proof of the Canonicity Criterion, we can define a chain of models  $\mathcal{C}_K = \{\underline{K}_n, V_n, f_n\}_{n \geq 1}$ , where the  $V_n$ -separable model  $\underline{K}_n$  is based on the frame  $\underline{P}_n$ . Let us consider the  $L$ -saturated set  $\Delta = \bigcup_{n \geq 1} \Gamma_{\underline{K}_n}^{V_n}(\rho_n)$ ; since  $L$  is strongly complete, there must be a model  $\underline{K} = \langle P, \leq, \rho, \Vdash \rangle$  such that  $\Gamma_{\underline{K}}(\rho) = \Delta$  and  $\underline{P} = \langle P, \leq, \rho \rangle$  is a frame for  $L$ . Since the models  $\underline{K}_n$  are finite, we can apply Proposition 4.1 and claim that  $\underline{K}$  is a weak limit of  $\mathcal{C}_K$ ; this means that  $\underline{P}$  is a weak limit of  $\mathcal{C}$ . ■

This theorem is not of great use if our concern is to disprove the strong completeness of  $L$ ; indeed, we should check that *all* the weak limits of the chain  $\mathcal{C}$  are not frames for  $L$ . On the other hand, we can limit ourselves to study particular frames, namely the stable reductions of the limit of  $\mathcal{C}$ , which convey useful information about weak limits. Let  $\mathcal{C} = \{\underline{P}_n, f_n\}_{n \geq 1}$  be a chain of frames and let  $\underline{P}^* = \langle P^*, \leq^* \rangle$  be the limit of  $\mathcal{C}$ . We say that  $\alpha^* \in P^*$  is *stable* if we definitively (i.e., for all  $n$  greater than some integer  $k$ ) have that  $\alpha_n$  has only one preimage with respect to  $f_n$ .

**Proposition 4.3.** Let  $\mathcal{C} = \{\underline{P}_n, f_n\}_{n \geq 1}$  be a chain of frames  $\underline{P}_n = \langle P_n, \leq_n, \rho_n \rangle$ , let  $\underline{P}^* = \langle P^*, \leq^*, \rho^* \rangle$  be the limit of  $\mathcal{C}$  and let  $\underline{P} = \langle P, \leq, \rho \rangle$  be a weak limit of  $\mathcal{C}$ . Then there is a map  $h : P \rightarrow P^*$  such that:

- (i)  $h(\rho) = \rho^*$ ;
- (ii)  $\alpha \leq \beta$  implies  $h(\alpha) \leq^* h(\beta)$ ;
- (iii) if  $h(\alpha) <^* \beta^*$  and  $\beta^*$  is stable, then there is  $\beta \in P$  s.t.  $\alpha < \beta$  and  $h(\beta) = \beta^*$ .

**Proof.** Suppose that  $\underline{P}$  is a weak limit of  $\mathcal{C}$  having projections  $\{h_n\}_{n \geq 1}$  and let us define, for each  $\alpha \in P$ ,  $h(\alpha) = \langle h_1(\alpha), h_2(\alpha), \dots \rangle$ . By definition,  $h_n(\alpha) = f_n(h_{n+1}(\alpha))$  for every  $n \geq 1$ , hence  $h(\alpha)$  is a point of  $\underline{P}^*$  and  $h$  is a map from  $\underline{P}$  to  $\underline{P}^*$ . It is immediate to prove that  $h(\rho) = \langle \rho_1, \rho_2, \dots \rangle = \rho^*$  and that  $h$  is order preserving. Suppose now that  $h(\alpha) <^* \beta^*$  (i.e.  $h_n(\alpha) \leq_n$

$\beta_n$  for every  $n \geq 1$ ) and that  $\beta^* = \langle \beta_1, \beta_2, \dots \rangle$  is stable. Then there is  $n$  such that, for every  $k \geq n$ ,  $\beta_{k+1}$  is the only preimage of  $\beta_k$  with respect to  $f_k$ . Since  $h_n(\alpha) <_n \beta_n$ , there is  $\beta \in P$  such that  $\alpha < \beta$  and  $h_n(\beta) = \beta_n$ ; by induction on  $j$ , we can prove that  $h_j(\beta) = \beta_j$  for every  $j \geq n$ . This also implies that  $h_j(\beta) = \beta_j$  for every  $j \geq 1$ , thus:

$$h(\beta) = \langle h_1(\beta), h_2(\beta), \dots \rangle = \langle \beta_1, \beta_2, \dots \rangle = \beta^*$$

and (iii) is proved.  $\blacksquare$

We remark that the map  $h$  of the previous proposition is not, in general, a p-morphism, since the ‘‘openness’’ property is guaranteed only for the stable points of  $\underline{P}^*$  (thus, in general, it may be not even surjective).

Now we show that the stable points of a full model of a logic have a primary importance in determining the strong completeness. To this aim, we introduce the following definition.

**Definition 4.4.** Let  $\mathcal{C} = \{\underline{P}_n, f_n\}_{n \geq 1}$  be a chain of frames and let  $\underline{P}^* = \langle P^*, \leq^* \rangle$  be the limit of  $\mathcal{C}$ . We say that  $\underline{P} = \langle P, \leq \rangle$  is a *stable reduction* of  $\underline{P}^*$  iff there is a p-morphism  $g$  from  $\underline{P}^*$  onto  $\underline{P}$  such that, for every  $\alpha^* \in P^*$  and every  $\beta \in P$ , the following holds:

- if  $g(\alpha^*) < \beta$ , then there is  $\beta^* \in P^*$  s.t.  $\alpha^* <^* \beta^*$ ,  $\beta^*$  is stable and  $g(\beta^*) = \beta$ .

**Proposition 4.5.** Let  $\mathcal{C} = \{\underline{P}_n, f_n\}_{n \geq 1}$  be a chain of frames  $\underline{P}_n = \langle P_n, \leq_n, \rho_n \rangle$ , let  $\underline{P} = \langle P, \leq, \rho \rangle$  be a weak limit of  $\mathcal{C}$  and let  $\underline{P}' = \langle P', \leq', \rho' \rangle$  be a stable reduction of the limit  $\underline{P}^*$  of  $\mathcal{C}$ . Then there is a p-morphism  $f$  from  $\underline{P}$  onto  $\underline{P}'$ .

**Proof.** Let  $\underline{P}^* = \langle P^*, \leq^*, \rho^* \rangle$  be the limit of  $\mathcal{C}$ , let  $h : P \rightarrow P^*$  be the map defined in Proposition 4.3 and let  $g : P^* \rightarrow P'$  be as in the definition of stable reduction. We know that  $h$  is ‘‘almost’’ a p-morphism, while  $g$  is ‘‘much more’’ than a p-morphism; we show that the composite map  $f = g \circ h$  is a p-morphism. It is immediate to prove that  $f$  is order preserving. Suppose now that  $g(h(\alpha)) <' \beta'$ , for some  $\alpha \in P$  and  $\beta' \in P'$ . By definition of  $g$ , there is  $\beta^* \in P^*$  such that  $\beta^*$  is stable,  $h(\alpha) <^* \beta^*$  and  $g(\beta^*) = \beta'$ . By definition of  $h$ , there is  $\beta \in P$  such that  $\alpha < \beta$  and  $h(\beta) = \beta^*$ , hence  $g(h(\beta)) = \beta'$ . Finally,  $g(h(\rho)) = g(\rho^*) = \rho'$ , thus  $f$  is also surjective and the proposition is proved.  $\blacksquare$

This can be depicted by the commutative diagram in Figure 2, where we have put into evidence the arrows which represent p-morphisms. It fol-

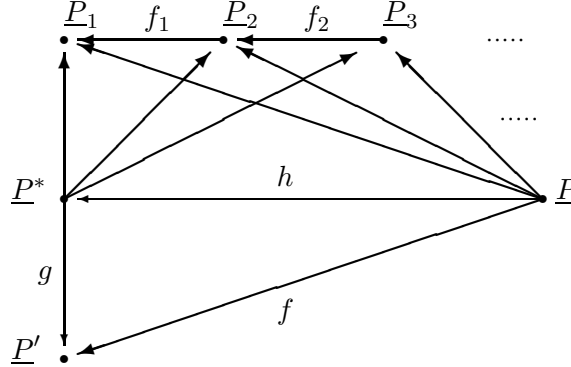

Figure 2: Diagram of weak limits

lows that any stable reduction of the limit of  $\mathcal{C}$  is representative, in some sense, of all the weak limits of  $\mathcal{C}$ ; thus, our Necessary Condition for Strong Completeness can be reformulated in the following more interesting form.

**Theorem 4.6 (Strong Completeness Criterion).** *Let  $L$  be a strongly complete logic, let  $\mathcal{C} = \{\underline{P}_n, f_n\}_{n \geq 1}$  be a chain of finite frames  $\underline{P}_n = \langle P_n, \leq_n, \rho_n \rangle$  for  $L$ , and let  $\underline{P}' = \langle P', \leq', \rho' \rangle$  be a stable reduction of the limit  $\underline{P}^*$  of  $\mathcal{C}$ . Then  $\underline{P}'$  is a frame for  $L$ .*

**Proof.** Since  $L$  is strongly complete, by the Necessary Condition for Strong Completeness there must be a weak limit  $\underline{P} = \langle P, \leq, \rho \rangle$  of  $\mathcal{C}$  such that  $\underline{P}$  is a frame for  $L$ . By Proposition 4.5, there is a p-morphism from  $\underline{P}$  onto  $\underline{P}'$ ; since  $\underline{P}$  is a frame for  $L$ , we can conclude that also  $\underline{P}'$  is a frame for  $L$ . ■

Thus, to disprove the strong completeness of a logic, we can restrict ourselves to study the stable reductions of the limits. We also point out that the previous criterion is more general than the corresponding one explained in [10].

### 5. The logics in one variable

The logics in one variable are the superintuitionistic logics having as extra axiom a formula in one variable (see for instance [1, 3, 10]). In or-

der to describe the non intuitionistically equivalent formulas in one variable  $p$ , we consider the model  $\underline{K}_\omega = \langle P_\omega, \leq, \sigma_\omega, \Vdash \rangle$  defined on the frame  $\underline{P}_\omega = \langle P_\omega, \leq, \sigma_\omega \rangle$  of Figure 3 (where straight lines represent the immediate successor relation) and the forcing relation is defined in such a way that  $\delta \Vdash q$  if and only if  $\delta \equiv \sigma_1$  and  $q \equiv p$ . Let us consider the following sequence

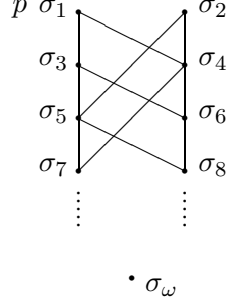

Figure 3: The model  $\underline{K}_\omega$

of formulas:

$$\begin{aligned} \mathbf{nf}_1 &= p & \mathbf{nf}_2 &= \neg p & \mathbf{nf}_3 &= \neg\neg p & \mathbf{nf}_4 &= \neg\neg p \rightarrow p \\ \mathbf{nf}_k &= \mathbf{nf}_{k-1} \rightarrow \mathbf{nf}_{k-3} \vee \mathbf{nf}_{k-4} & & & & & & \text{for every } k \geq 5. \end{aligned}$$

The formulas  $\mathbf{nf}_k$  (possibly with different enumerations) are also known in the literature as *Nishimura-formulas* [17] and have the following properties:

- $\delta \Vdash \mathbf{nf}_k$  if and only if  $\sigma_k \leq \delta$ ;
- $\sigma_m \leq \sigma_n$  implies  $\vdash_{INT} \mathbf{nf}_n \rightarrow \mathbf{nf}_m$ ;
- for every  $\{p\}$ -formula  $A$ , there are  $n, m \geq 1$  such that  $\vdash_{INT} A \leftrightarrow \mathbf{nf}_n \vee \mathbf{nf}_m$ .

Therefore every  $\{p\}$ -formula is intuitionistically equivalent to some formula of the kind  $\mathbf{nf}_k$  or  $\mathbf{nf}_k \vee \mathbf{nf}_{k+1}$ , for some  $k \geq 1$ . In correspondence, we can give the following list of the logics in one variable.

- $\mathbf{Int} + (\mathbf{nf}_1 \vee \mathbf{nf}_2) = \mathbf{Int} + \mathbf{nf}_4 = \mathbf{Cl}$ .
- $\mathbf{Int} + (\mathbf{nf}_2 \vee \mathbf{nf}_3) = \mathbf{Int} + \mathbf{nf}_5 = \mathbf{Jn}$   
(*Jankov logic* or *Weak excluded middle logic*).
- $\mathbf{NL}_m = \mathbf{Int} + \mathbf{nf}_m$ , for every  $m \geq 6$ .
- $\mathbf{NL}_{n,n+1} = \mathbf{Int} + (\mathbf{nf}_n \vee \mathbf{nf}_{n+1})$ , for every  $n \geq 3$ .

We point out that the logic  $\mathbf{NL}_6$  corresponds to the *Scott logic St* [3, 6], while  $\mathbf{NL}_7$  is also known as *Anti-Scott logic Ast* [7]. All these logics have a simple semantical characterization (see [10]). Let us call  $\underline{P}_{\sigma_k}$  the generated subframe of  $\underline{P}_\omega$  having root  $\sigma_k$  and  $\underline{P}_{\sigma_k, k+1}$  the frame obtained by the union of  $\underline{P}_{\sigma_k}$  and  $\underline{P}_{\sigma_{k+1}}$ . For a frame  $\underline{P}$ , let  $\text{Spl}(\underline{P})$  denote the class of frames  $\underline{P}'$  such that, for every generated subframe  $\underline{P}''$  contained in some cone  $\underline{P}'_\alpha$  of  $\underline{P}'$ , there are no p-morphisms from  $\underline{P}''$  onto  $\underline{P}$ . Then:

**Proposition 5.1.** *Let  $\underline{P}$  be any frame.*

- (i)  $\underline{P}$  is a frame for the logic  $\mathbf{NL}_{m+1}$ , for  $m \geq 3$ , iff  $\underline{P} \in \text{Spl}(\underline{P}_{\sigma_m})$ .
- (ii)  $\underline{P}$  is a frame for the logic  $\mathbf{NL}_{n+1, n+2}$ , for  $n \geq 1$ , iff  $\underline{P} \in \text{Spl}(\underline{P}_{\sigma_{n, n+1}})$ .

As a consequence of a result due to Sobolev [19], the *finite* frames quoted in the previous proposition characterize the corresponding logics. In some cases we can describe the frames characterizing these logics without any reference to p-morphisms. For instance, let us say that a frame  $\underline{P} = \langle P, \leq \rangle$  is *strongly directed* if, for every  $\alpha, \beta, \gamma \in P$  s.t.  $\alpha \leq \beta$  and  $\alpha \leq \gamma$ , there is  $\delta \in P$  such that  $\beta \leq \delta$  e  $\gamma \leq \delta$ . It is easy to prove that the frames for  $\mathbf{Jn}$  are just the strongly directed frames (see also [3]).

As regards the logic  $\mathbf{St}$  and  $\mathbf{Ast}$ , we can characterize the class of frames of finite depth. Let  $\underline{P} = \langle P, \leq \rangle$  be a frame, let  $\alpha$  be a non-final point of  $\underline{P}$  and let  $\varphi$  and  $\psi$  be two final points of  $\underline{P}$ . We say that  $\alpha$  is *prefinal* iff, for every  $\delta > \alpha$ ,  $\delta$  is final. We say that  $\varphi$  and  $\psi$  are *prefinally connected in  $\underline{P}$*  iff either  $\varphi = \psi$  or there is a sequence  $\varphi_1, \dots, \varphi_n$  ( $n > 1$ ) of final points of  $\underline{P}$  satisfying the following conditions:

- (1)  $\varphi_1 = \varphi$  and  $\varphi_n = \psi$ ;
- (2) for  $1 \leq i \leq n - 1$ , there is  $\alpha \in P$  s.t.  $\alpha$  is prefinal and  $\{\varphi_i, \varphi_{i+1}\} \subseteq \text{Fin}(\alpha)$ .

It is not difficult to see that we can extend the result of [6] regarding the characterization of the finite frames for  $\mathbf{Ast}$  in the following way.

**Proposition 5.2.** *Let  $\underline{P} = \langle P, \leq \rangle$  be a frame having finite depth.  $\underline{P}$  is a frame for the logic  $\mathbf{St}$  iff, for every  $\alpha \in P$  and for every  $\varphi$  and  $\psi$  belonging to  $\text{Fin}(\alpha)$ ,  $\varphi$  and  $\psi$  are prefinally connected in  $\underline{P}_\alpha$ .*

We remark that the condition of “prefinal connection” cannot be expressed by a first-order formula, and the problem lies in the unbounded number of

final points involved in the definition. A formal proof of this fact can be accomplished by a standard application of the classical Compactness theorem (see for instance [4]).

The frames for the logic **Ast** with finite depth satisfy a condition which can be expressed by a first-order sentence, as in the statement of the next proposition (this is a generalization of [7], where such a condition is introduced to characterize the finite frames for **Ast**).

**Proposition 5.3.** *Let  $\underline{P} = \langle P, \leq \rangle$  be a frame having finite depth.  $\underline{P}$  is a frame for the logic **Ast** if and only if, for every  $\alpha \in P$ , if  $\alpha$  is a non-final point of  $\underline{P}$ , then one of the following conditions (a) or (b) is satisfied.*

- (a) *For every immediate successor  $\delta$  of  $\alpha$ ,  $|Fin(\delta)| = 1$ .*
- (b) *For any two immediate successors  $\beta$  and  $\gamma$  of  $\alpha$  in  $\underline{P}$ , if  $\beta$  and  $\gamma$  are non-final, then  $Fin(\beta) = Fin(\gamma)$ .*

### 5.1. The canonical logics in one variable

The first four logics in our enumeration turn out to be canonical. Indeed, **Cl** is evidently hypercanonical, and it is not difficult to prove that also **Jn** is hypercanonical (see Section 8); moreover, the logics **NL<sub>3,4</sub>** and **NL<sub>4,5</sub>** are hypercanonical and extensively canonical respectively. We only prove the latter fact (the proof of the former is similar).

**Theorem 5.4.** *The logic **NL<sub>4,5</sub>** is extensively canonical.*

**Proof.** Suppose that, by absurd, such a logic is not extensively canonical; then there is a well separable model  $\underline{K} = \langle P, \leq, \Vdash \rangle$  of **NL<sub>4,5</sub>** whose frame  $\underline{P} = \langle P, \leq \rangle$  is not a frame for **NL<sub>4,5</sub>**. This implies that there are some points  $\alpha, \beta, \varphi_1, \varphi_2$  of  $\underline{P}$  such that:

- $\alpha < \beta$  and  $\alpha < \gamma$ ;
- $\beta$  and  $\gamma$  are two distinct non-final points s.t.  $\beta \not\prec \gamma$  and  $\gamma \not\prec \beta$ ;
- $\varphi_1$  and  $\varphi_2$  are two distinct final points s.t.  $\gamma < \varphi_1$ ,  $\gamma < \varphi_2$  and  $\beta \not\prec \varphi_2$ .

By the well separability of  $\underline{K}$ , there are some formulas  $A, B, C$  such that:

- $\beta \Vdash A$  and  $\varphi_2 \not\Vdash A$  (hence  $\varphi_2 \Vdash \neg A$ );
- $\varphi_1 \Vdash B$  and  $\varphi_2 \not\Vdash B$  (hence  $\varphi_2 \Vdash \neg B$ );
- $\gamma \Vdash C$  and  $\beta \not\Vdash C$ .

Moreover, since  $\beta$  is not final, there is a formula  $D$  such that  $\beta \Vdash \neg\neg D$  and  $\beta \nVdash D$ . Let us take the formula  $H = \neg\neg(A \vee B) \wedge (D \vee C)$ . Then:

- $\beta \nVdash \neg\neg H \rightarrow H$  (indeed,  $\beta \Vdash \neg\neg H$  and  $\beta \nVdash H$ );
- $\gamma \Vdash \neg\neg H \rightarrow H$ ,  $\gamma \nVdash \neg H$  (indeed,  $\varphi_1 \Vdash H$ ) and  $\gamma \nVdash H$  (indeed,  $\varphi_2 \Vdash \neg H$ ).

It follows that  $\alpha \nVdash (\neg\neg H \rightarrow H) \vee ((\neg\neg H \rightarrow H) \rightarrow H \vee \neg H)$ , which is an instance of  $\mathbf{nf}_{4,5}$ , a contradiction; hence  $\mathbf{NL}_{4,5}$  is extensively canonical. ■

We show that, in the previous proof, the hypothesis of well separability (used to separate  $\gamma$  from  $\beta$ ) is essential.

**Theorem 5.5.** *The logic  $\mathbf{NL}_{4,5}$  is not hypercanonical.*

**Proof.** Let us take the chain of frames  $\mathcal{C} = \{\underline{P}_n, f_n\}_{n \geq 1}$ , where the frame  $\underline{P}_n = \langle P_n, \leq_n, r \rangle$  and the p-morphism  $f_n$  from  $\underline{P}_{n+1}$  onto  $\underline{P}_n$ , for each  $n \geq 1$ , are defined as follows:

- $P_n = \{r, a, b_1, \dots, b_n, \beta, c, d\}$ ;
- the ordering relation  $\leq_n$  is defined as in Figure 4;
- $f_n(b_{n+1}) = \beta$  and  $f_n(\delta) = \delta$  for  $\delta \neq b_{n+1}$ .

Clearly,  $\underline{P}_n$  is a frame for  $\mathbf{NL}_{4,5}$ . Let us consider the infinite frame  $\underline{P} =$

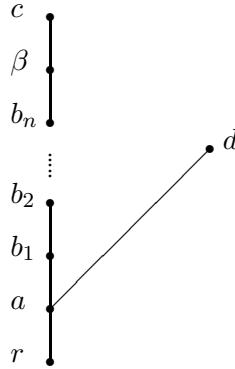
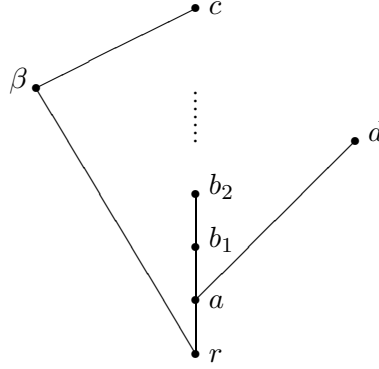

Figure 4: The frame  $\underline{P}_n$  for  $\mathbf{NL}_{4,5}$ .

$\langle P, \leq, r \rangle$ , where:

- $P = \{r, a, b_1, b_2, \dots, \beta, c, d\}$ ;
- the ordering relation  $\leq$  is defined as in Figure 5.

We point out that, for every  $n \geq 1$ ,  $b_n < c$  and  $b_n \not\leq \beta$ . It is easy to prove

Figure 5: The well separable weak limit  $\underline{P}$ 

that  $\underline{P}$  is a separable weak limit of  $\mathcal{C}$  with projections  $\{h_n\}_{n \geq 1}$  defined as follows:

- $h_n(b_k) = \beta$  for every  $k \geq n + 1$ ;
- $h_n(\delta) = \delta$  for all the other points  $\delta$ .

Since  $\underline{P}$  is not a frame for  $\mathbf{NL}_{4,5}$ , by the Hypercanonicity Criterion we can conclude that  $\mathbf{NL}_{4,5}$  is not hypercanonical.  $\blacksquare$

We observe that, in the previous proof, the frame  $\underline{P}$  is not a well separable weak limit of  $\mathcal{C}$  (for instance, it holds that  $h_n(a) \leq_n h_n(\beta)$  for every  $n \geq 1$ , while it is not true that  $a \leq \beta$ ), as it is expected by the fact that  $\mathbf{NL}_{4,5}$  is extensively canonical and by the Extensive Canonicity Criterion. To obtain a well separable weak limit with the same projections, we have to put  $\beta$  over all the points  $b_n$  (clearly, the frame so obtained is a frame for  $\mathbf{NL}_{4,5}$ ).

## 5.2. The Scott logic $\mathbf{St}$

As anticipated in the Introduction, all the other logics in one variable are not strongly complete. Let us examine the case of  $\mathbf{St}$ .

**Theorem 5.6.** *The logic  $\mathbf{St}$  is not strongly complete.*

**Proof.** We show a chain  $\mathcal{C} = \{\underline{P}_n, f_n\}_{n \geq 1}$  of finite frames  $\underline{P}_n = \langle P_n, \leq_n, r \rangle$  for  $\mathbf{St}$  such that the frame  $\underline{P}_{\sigma_5}$  is a stable reduction of the limit  $\underline{P}^* = \langle P^*, \leq^*, r^* \rangle$  of  $\mathcal{C}$ . Let  $\underline{P}_n$  be defined as follows:



- $P_n = \{r, a_1, \dots, a_n, \alpha, b, d_1, \dots, d_n, \delta\}$ ;
- the ordering relation  $\leq_n$  is defined as in Figure 6.

The p-morphism  $f_n$  from  $\underline{P}_{n+1}$  onto  $\underline{P}_n$  is defined as follows:

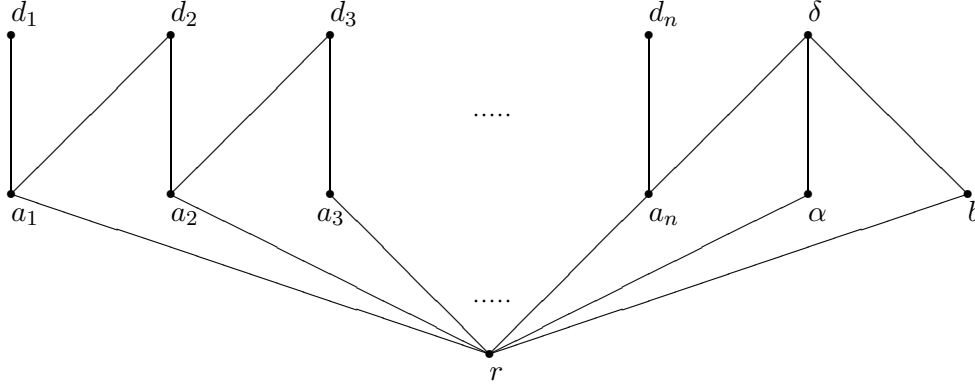

Figure 6: The frame  $\underline{P}_n$  for **St**

- $f_n(a_{n+1}) = \alpha, f_n(d_{n+1}) = \delta$ ;
- $f_n(\beta) = \beta$  for all the other points  $\beta$ .

The limit model  $\underline{P}^*$  contains the stable points  $r_n^* = \langle r, r, \dots \rangle$ ,  $a_n^* = \langle \alpha, \dots, \alpha, a_n, a_n, \dots \rangle$  (where  $\alpha$  occurs in the first  $n - 1$  components and  $a_n$  in the remaining ones),  $b^* = \langle b, b, \dots \rangle$ ,  $d_n^* = \langle \delta, \dots, d_n, \dots \rangle$ , and the non-stable points  $\alpha^* = \langle \alpha, \alpha, \dots \rangle$  and  $\delta^* = \langle \delta, \delta, \dots \rangle$ ; the ordering relation between these points is described by Figure 7. Finally, let  $g$  be the p-

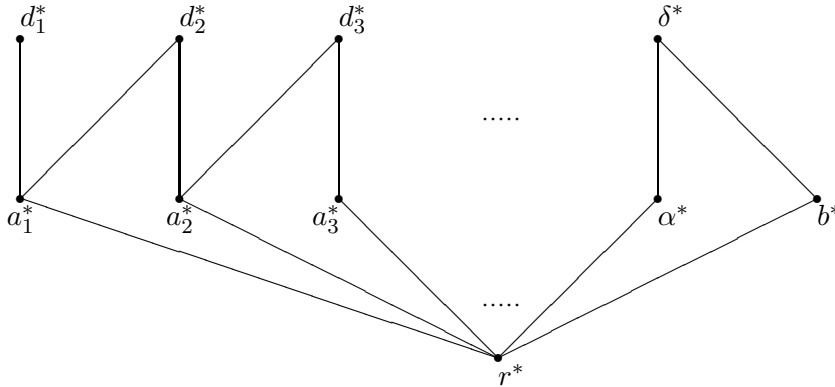

Figure 7: The limit frame  $\underline{P}^*$

morphism from  $\underline{P}^*$  onto  $\underline{P}_{\sigma_5}$  defined as follows:

- $g(d_n^*) = \sigma_1$ , for every  $n \geq 1$ ;
- $g(\alpha^*) = g(b^*) = g(\delta^*) = \sigma_2$ ;
- $g(a_n^*) = \sigma_3$ , for every  $n \geq 1$ ;
- $g(r^*) = \sigma_5$ .

By definition of  $g$ ,  $\underline{P}_{\sigma_5}$  is a stable reduction of  $\underline{P}^*$ ; we can apply the Strong Completeness Criterion and claim that **St** is not strongly complete. ■

We point out that, if we are only interested in disproving the canonicity of **St**, we can limit ourselves to observe that the limit  $\underline{P}^*$  of  $\mathcal{C}$  is not a frame for **St** and then apply the Canonicity Criterion. We take advantage of this example to observe that, in general, the limit of a chain  $\mathcal{C}$  does not inherit the *first-order properties* which hold in all frames  $\underline{P}_n$  of  $\mathcal{C}$ . As a matter of fact, in all  $\underline{P}_n$  there is a final point, that is  $\delta$ , which is an immediate successor of three distinct points of  $\underline{P}_n$ , and this can be expressed by a first-order sentence; on the other hand, the limit  $\underline{P}^*$  of  $\mathcal{C}$  does not enjoy this property. Finally, we observe that all the frames involved in the previous proof have depth 3; this implies that the proof works also in the case we consider the family of logics of **St** of finite depth.

More precisely, let us consider the following sequence of formulas:

$$\mathbf{bd}_1 = p_1 \vee \neg p_1 \quad \mathbf{bd}_{n+1} = p_{n+1} \vee (p_{n+1} \rightarrow \mathbf{bd}_n)$$

and let  $\mathbf{Bd}_n$  be the intermediate logic  $\mathbf{Int} + \mathbf{bd}_n$ . It is well known that  $\mathbf{Bd}_n$  is the logic of the frames having depth at most  $n$  (see [3]); one can also easily show that  $\mathbf{Bd}_n$  is hypercanonical. Clearly,  $\underline{P}$  is a frame for the logic  $\mathbf{St} + \mathbf{Bd}_h$  if and only if  $\underline{P}$  is a frame for **St** and  $\underline{P}$  has depth at most  $h$ .

**Theorem 5.7.** (i) *The logics  $\mathbf{St} + \mathbf{Bd}_h$ , for  $h < 3$ , are hypercanonical.*  
(ii) *The logics  $\mathbf{St} + \mathbf{Bd}_h$ , for  $h \geq 3$ , are not strongly complete.*

**Proof.** (i) Let  $\underline{K} = \langle P, \leq, \Vdash \rangle$  be a separable model of  $\mathbf{St} + \mathbf{Bd}_h$ , with  $h < 3$ . Then the frame  $\underline{P}$  of  $\underline{K}$  has depth at most 2, otherwise an instance of  $\mathbf{bd}_h$  is not valid in  $\underline{K}$ ; this immediately implies that  $\underline{P}$  is also a frame for **St**.

(ii) It is proved as Theorem 5.6, observing that the frames of the chain  $\mathcal{C}$  are frames for the logic  $\mathbf{St} + \mathbf{Bd}_h$ . ■

### 5.3. The logics $\mathbf{NL}_{m+1}$ ( $m \geq 7$ ) and $\mathbf{NL}_{n+1,n+2}$ ( $n \geq 4$ )

By the fact that the frames  $\underline{P}_{\sigma_m}$  and  $\underline{P}_{\sigma_{n,n+1}}$ , for  $m \geq 7$  and  $n \geq 4$ , contain  $\underline{P}_{\sigma_5}$  as generated subframe, we can extend without great effort the proof of non strong completeness of  $\mathbf{St}$  to the logics  $\mathbf{NL}_{m+1}$  and  $\mathbf{NL}_{n+1,n+2}$  (namely, the logics in one variable strictly included in  $\mathbf{St}$ ).

**Theorem 5.8.** (i) *The logics  $\mathbf{NL}_{m+1}$ , for  $m \geq 7$ , are not strongly complete.*

(ii) *The logics  $\mathbf{NL}_{m+1,m+2}$ , for  $m \geq 4$ , are not strongly complete.*

**Proof.** (i) Let  $m \geq 7$ ; we define a chain  $\mathcal{C} = \{\underline{P}_n, f_n\}_{n \geq 1}$  of finite frames  $\underline{P}_n = \langle P_n, \leq_n, t_m \rangle$  for  $\mathbf{NL}_{m+1}$  such that  $\underline{P}_{\sigma_m}$  is a stable reduction of the limit  $\underline{P}^* = \langle P^*, \leq^*, t_m \rangle$  of  $\mathcal{C}$ . Let  $\underline{P}'_n = \langle P'_n, \leq'_n, t_5 \rangle$  be the frame defined as the frame  $\underline{P}_n$  in the proof of Theorem 5.6, where  $t_5$  coincides with  $r$ ; then the frame  $\underline{P}_n$  is defined as in Figure 8. The p-morphism  $f_n$  is defined as in

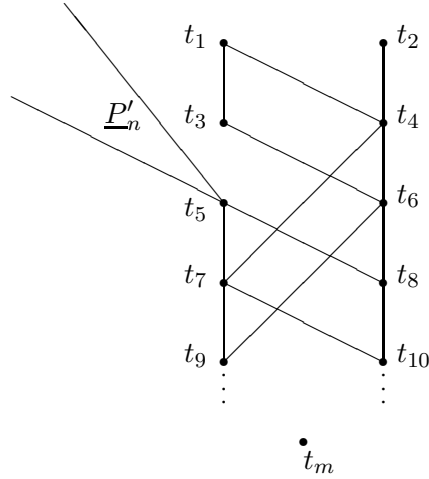
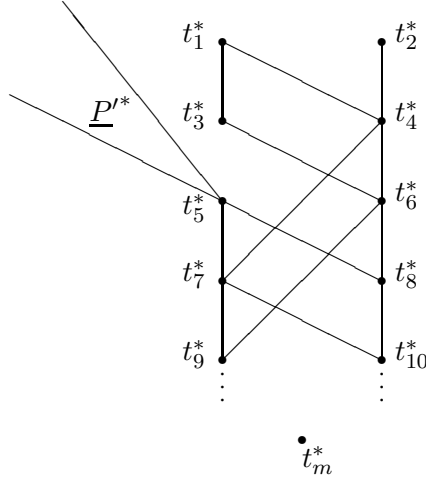

Figure 8: The frame  $\underline{P}_n$  for  $\mathbf{NL}_{m+1}$

the proof of Theorem 5.6 on the points  $\beta > t_5$  and  $f_n(\beta) = \beta$  if  $\beta$  is one of the points  $t_k$ . Finally, the limit frame  $\underline{P}^*$  of  $\mathcal{C}$  is defined as in Figure 9, where  $\underline{P}'^*$  coincides with the limit frame in the proof of Theorem 5.6. Since  $\underline{P}_{\sigma_m}$  is a stable reduction of  $\underline{P}^*$ , by the Strong Completeness Criterion  $\mathbf{NL}_{m+1}$  is not strongly complete.

(ii) We can proceed as in (i) taking, as frame  $\underline{P}_n = \langle P_n, \leq_n, t \rangle$  for the logic  $\mathbf{NL}_{m+1,m+2}$  ( $m \geq 4$ ), the one in Figure 10. The p-morphisms  $f_n$  and the

Figure 9: The limit frame  $\underline{P}^*$ 

limit  $\underline{P}^* = \langle P^*, \leq^*, t^* \rangle$  are defined similarly to in (i). Let us consider the frame  $\underline{P}_{\tilde{\sigma}_m}$  in Figure 11. Since  $\underline{P}_{\tilde{\sigma}_m}$  is a stable reduction of  $\underline{P}^*$  and  $\underline{P}_{\tilde{\sigma}_m}$  is not a frame for  $\mathbf{NL}_{m+1, m+2}$ , it follows that  $\mathbf{NL}_{m+1, m+2}$  is not strongly complete.  $\blacksquare$

As in the case of  $\mathbf{St}$ , one can observe that the frames used in the previous proof have minimal depth; thus we can refine the previous theorem as follows.

**Theorem 5.9.** (i) Let  $m \geq 7$  and let  $h_m = \text{depth}(\underline{P}_{\sigma_m})$ . Then:

- for  $1 \leq h < h_m$ ,  $\mathbf{NL}_{m+1} + \mathbf{Bd}_h$  is hypercanonical;
- for  $h \geq h_m$ ,  $\mathbf{NL}_{m+1} + \mathbf{Bd}_h$  is not strongly complete.

(ii) Let  $m \geq 4$  and let  $k_m = \text{depth}(\underline{P}_{\sigma_{m, m+1}}) + 1$ . Then:

- for  $1 \leq h < k_m$ ,  $\mathbf{NL}_{m+1, m+2} + \mathbf{Bd}_h$  is hypercanonical;
- for  $h \geq k_m$ ,  $\mathbf{NL}_{m+1, m+2} + \mathbf{Bd}_h$  is not strongly complete.

#### 5.4. The Anti-Scott logic $\mathbf{Ast}$

It only remains to analyze the logic  $\mathbf{NL}_7 = \mathbf{Ast}$  (not included in  $\mathbf{St}$ ) which has a peculiar behaviour.

**Theorem 5.10.** The logic  $\mathbf{Ast}$  is not strongly complete.

**Proof.** Let us consider the chain  $\mathcal{C} = \{\underline{P}_n, f_n\}_{n \geq 1}$  of finite frames  $\underline{P}_n = \langle P_n, \leq_n, a_1 \rangle$  for  $\mathbf{Ast}$  such that, for every  $n \geq 1$ , the following holds:

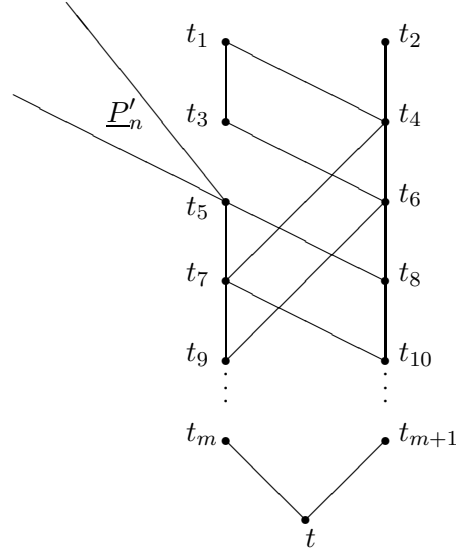
Figure 10: The frame  $\underline{P}'_n$  for  $\mathbf{NL}_{m+1, m+2}$ 

- $P_n = \{a_1, \dots, a_{n+1}, \alpha, e, b_1, \dots, b_n, \beta, g, d_1, \dots, d_n, \delta\}$ ;
- the ordering relation is defined as in Figure 12;
- $f_n(a_{n+2}) = \alpha$ ,  $f_n(b_{n+1}) = \beta$ ,  $f_n(d_{n+1}) = \delta$ ;
- $f_n(\gamma) = \gamma$  for all the other points  $\gamma$ .

The limit model  $\underline{P}^*$  contains the stable points  $a_n^* = \langle \alpha, \dots, \alpha, a_n, a_n, \dots \rangle$ ,  $b_n^* = \langle \beta, \dots, \beta, b_n, b_n, \dots \rangle$ ,  $d_n^* = \langle \delta, \dots, \delta, d_n, d_n, \dots \rangle$ ,  $e^* = \langle e, e, \dots \rangle$ ,  $g^* = \langle g, g, \dots \rangle$  and the non-stable points  $\alpha^* = \langle \alpha, \alpha, \dots \rangle$ ,  $\beta^* = \langle \beta, \beta, \dots \rangle$ ,  $\delta^* = \langle \delta, \delta, \dots \rangle$ ; the ordering relation is described by Figure 13. Finally,  $\underline{P}_{\sigma_6}$  is a stable reduction of  $\underline{P}^*$ , as proved by the following map  $g$ :

- $g(\beta^*) = g(g^*) = g(\delta^*) = \sigma_1$ ;
- $g(d_n^*) = \sigma_2$ , for every  $n \geq 1$ ;
- $g(\alpha^*) = g(e^*) = \sigma_3$ ;
- $g(b_n^*) = \sigma_4$ , for every  $n \geq 1$ ;
- $g(a_n^*) = \sigma_6$ , for every  $n \geq 1$ .

Thus **Ast** is not strongly complete. ■

We observe that the chain used to disprove the canonicity of **Ast** contains frames of increasing depth, so that the limit has infinite depth. We

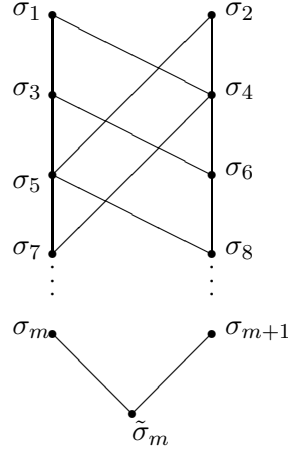
Figure 11: The frame  $\underline{P}_{\tilde{\sigma}_m}$ 

may wonder whether we can use chains of frames of bounded depth, as in the case of the other non canonical logics in one variable. The answer is negative since, if we fix an upper bound on the depth of the frames, we obtain canonical logics. This fact is not surprising since, using suitable filtration techniques (for instance, the ones explained in [6]), one can prove that the logic  $\mathbf{Ast} + \mathbf{Bd}_h$  is characterized by the class of frames for  $\mathbf{Ast}$  with depth at most  $h$  and, as seen in Proposition 5.3, such a class is first-order definable; thus, by Theorem 3.7 (van Benthem), the canonicity of such a logic follows. Nevertheless, here we give a direct proof of this fact, which enables us to get a more refined classification.

**Theorem 5.11.** *The logics  $\mathbf{Ast} + \mathbf{Bd}_h$ , for  $h \leq 3$ , are hypercanonical.*

**Proof.** We only consider the non trivial case of the logic  $L = \mathbf{Ast} + \mathbf{Bd}_3$ . Let  $\underline{K} = \langle P, \leq, \Vdash \rangle$  be a model of the logic  $L$ ; we show that the frame  $\underline{P} = \langle P, \leq \rangle$  is a frame for  $L$ . We immediately have that  $\underline{P}$  is a frame for  $\mathbf{Bd}_3$ ; let us suppose that  $\underline{P}$  is not a frame for  $\mathbf{Ast}$ . Then there are some points  $\alpha, \beta, \gamma, \varphi_1, \varphi_2, \varphi_3$  in  $\underline{P}$  such that:

- $\beta$  and  $\gamma$  are two distinct immediate successors of  $\alpha$ ;
- $\varphi_1, \varphi_2$  and  $\varphi_3$  are final points of  $\underline{P}$  such that  $\varphi_2 \neq \varphi_1$  and  $\varphi_2 \neq \varphi_3$ ;
- $\beta < \varphi_1, \gamma < \varphi_2, \gamma < \varphi_3$  and  $\beta \not< \varphi_2$ .

Let  $V$  be a finite set of propositional variables such that the points  $\alpha, \beta, \gamma, \varphi_1, \varphi_2, \varphi_3$  are pairwise  $V$ -separated, with the only exception that  $\Gamma_{\underline{K}}^V(\varphi_1)$

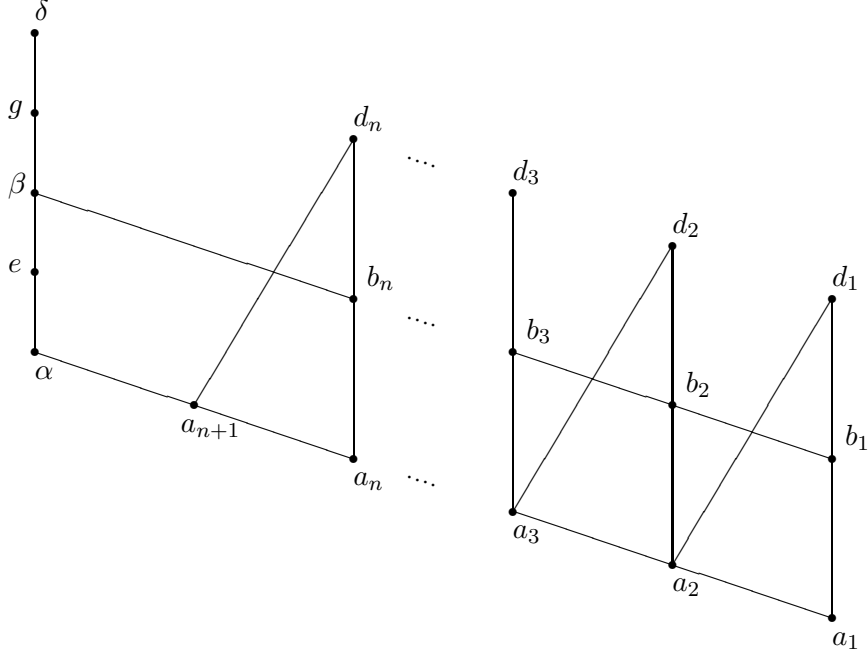
Figure 12: The frame  $\underline{P}_n$  for **Ast**

may coincide with  $\Gamma_{\underline{K}}^V(\varphi_3)$ ; in particular, we can assume that there is a  $V$ -formula  $A$  such that  $\beta \Vdash A$  and  $\varphi_2 \nVdash A$ . Let  $\underline{K}_V$  be the quotient model of  $\underline{K}$  with respect to the  $V$ -formulas (namely, w.r.t. the equivalence relation  $\equiv_V$ , where  $\delta \equiv_V \delta'$  iff  $\Gamma_{\underline{K}}^V(\delta) = \Gamma_{\underline{K}}^V(\delta')$ ) and, for each  $\delta \in P$ , let us denote with  $\delta_V$  the class to which  $\delta$  belongs. By definition,  $\delta_V < \delta'_V$  in  $\underline{K}_V$  iff  $\Gamma_{\underline{K}}^V(\delta) \subset \Gamma_{\underline{K}}^V(\delta')$ ; thus  $\alpha_V < \beta_V < \varphi_{1V}$ ,  $\alpha_V < \gamma_V$ ,  $\gamma_V < \varphi_{2V}$  and  $\gamma_V < \varphi_{3V}$ . It follows that  $\varphi_{1V}$ ,  $\varphi_{2V}$  and  $\varphi_{3V}$  are final,  $\beta_V$  and  $\gamma_V$  have depth 2 and  $\alpha_V$  has depth 3, thus  $\beta_V$  and  $\gamma_V$  are immediate successors of  $\alpha_V$ . Moreover, since  $\underline{K}_V$  is a  $V$ -separable finite model of **Ast**, the frame of  $\underline{K}_V$  is a finite frame for **Ast**. By Proposition 5.3, since  $\gamma_V$  sees more than one final point,  $\beta_V$  and  $\gamma_V$  (which are not final) must see the same final points, hence  $\beta_V < \varphi_{2V}$ . This gives rise to a contradiction, since  $\beta \Vdash A$  and  $\varphi_2 \nVdash A$  in  $\underline{K}$ , which implies that  $\beta_V \Vdash A$  and  $\varphi_{2V} \nVdash A$  in  $\underline{K}_V$ ; therefore  $\underline{P}$  is also a frame for **Ast**.  $\blacksquare$

If we now try to repeat the reasoning for the logics **Ast** + **Bd** $_h$ , with  $h \geq 4$ , we encounter some difficulties. Indeed, a key point of the proof is that  $\beta_V$  is an immediate successor of  $\alpha_V$  in  $\underline{K}_V$ . Nevertheless, it is not in general true that, if  $\beta$  is an immediate successor of  $\alpha$  in  $\underline{K}$ , then, for some

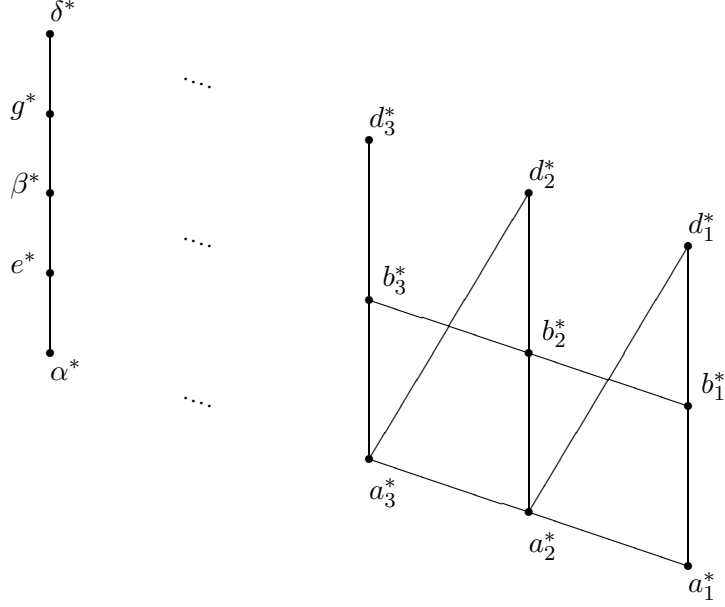
Figure 13: The limit frame  $\underline{P}^*$ 

finite set  $V$ ,  $\beta_V$  is an immediate successor of  $\alpha_V$  in  $\underline{K}_V$ , even if  $\underline{K}$  is full. Thus, to overcome the problem, more effort is required and the proof is rather involved.

**Theorem 5.12.** *The logics  $\mathbf{Ast} + \mathbf{Bd}_h$ , for  $h \geq 4$ , are canonical.*

**Proof.** Let us suppose that, for some  $h \geq 4$ , the logic  $L = \mathbf{Ast} + \mathbf{Bd}_h$  is not canonical. Then there is a full model  $\underline{K} = \langle P, \leq, \Vdash \rangle$  of  $L$  such that  $\underline{P} = \langle P, \leq \rangle$  is not a frame for  $L$ . As in the proof of Theorem 5.11, since evidently  $\underline{P}$  is a frame for  $\mathbf{Bd}_h$ , we can assume that there are  $\alpha, \beta, \gamma, \varphi_1, \varphi_2, \varphi_3$  in  $\underline{P}$  such that:

- $\beta$  and  $\gamma$  are two distinct immediate successors of  $\alpha$ ;
- $\varphi_1, \varphi_2$  and  $\varphi_3$  are final points of  $\underline{P}$  such that  $\varphi_2 \neq \varphi_1$  and  $\varphi_2 \neq \varphi_3$ ;
- $\beta < \varphi_1, \gamma < \varphi_2, \gamma < \varphi_3$  and  $\beta \not< \varphi_2$ .

Let us consider an increasing sequence of finite sets of propositional variables  $V_n$ , for  $n \geq 1$ , whose union is the set of all the variables; let  $\underline{K}_n = \langle P_n \leq_n, \Vdash_n \rangle$  be the quotient model of  $\underline{K}$  with respect to the  $V_n$ -formulas and let  $f_n$  be the map which associates, with each point  $\alpha$  in  $\underline{K}_{n+1}$ , the



(unique) point of  $\underline{K}_n$  in the same  $V_n$ -equivalence class. Since each  $\underline{K}_n$  is finite, we have that  $\mathcal{C}_K = \{\underline{K}_n, V_n, f_n\}_{n \geq 1}$  is a chain having limit  $\underline{K}$ , with projections  $\{h_n\}_{n \geq 1}$  defined in an obvious way. By the well separability of  $\underline{K}$  and by the fact that  $\alpha$  has finite depth, we can assume that there is  $\bar{n} \geq 1$  such that, for every  $j \geq \bar{n}$ , the following properties hold:

(P1) For any two distinct points  $\delta_1, \delta_2$  in the set  $\{\alpha, \beta, \gamma, \varphi_1, \varphi_2, \varphi_3\}$ ,  $h_j(\delta_1) \neq h_j(\delta_2)$ , with the only exception that  $h_j(\varphi_1)$  may coincide with  $h_j(\varphi_3)$ .

(P2) It is not true that  $h_j(\beta) <_j h_j(\varphi_2)$ .

(P3) The depth of  $h_{j+1}(\alpha)$  in  $\underline{K}_{j+1}$  does not exceed the depth of  $h_j(\alpha)$  in  $\underline{K}_j$ .

We observe that, for each  $n \geq 1$ ,  $\underline{P}_n$  is a finite frame for **Ast**; moreover, for  $j \geq \bar{n}$ , it is not the case that all the immediate successors of  $h_j(\alpha)$  see only one final point of  $\underline{K}_j$  (for instance, if  $\delta$  is an immediate successor of  $h_j(\alpha)$  such that  $\delta \leq_j h_j(\gamma)$ , then  $\delta$  sees at least the two distinct final points  $h_j(\varphi_2)$  and  $h_j(\varphi_3)$ ); thus, all the non-final immediate successors of  $h_j(\alpha)$  see the same final points. In particular:

(P4) For every  $j \geq \bar{n}$ , for every non-final immediate successor  $\delta$  of  $h_j(\alpha)$  in  $\underline{K}_j$ , it holds that  $\delta <_j h_j(\varphi_2)$ .

Now we show that:

(P5) There is  $\bar{m} \geq \bar{n}$  such that  $h_{\bar{m}}(\beta)$  is an immediate successor of  $h_{\bar{m}}(\alpha)$  in  $\underline{K}_{\bar{m}}$ .

Suppose that (P5) does not hold; then, for every  $j \geq \bar{n}$ , the set

$$\mathcal{D}_j = \{\delta \in P_j : h_j(\alpha) <_j \delta <_j h_j(\beta) \quad \text{and} \quad \delta <_j h_j(\varphi_2)\}$$

is nonempty. Moreover, it holds that:

(P6) For every  $j \geq \bar{n}$  and every  $\delta \in \mathcal{D}_{j+1}$ ,  $f_j(\delta) \in \mathcal{D}_j$ .

Indeed, since  $h_j = f_j \circ h_{j+1}$ , we immediately have that  $h_j(\alpha) \leq_j f_j(\delta) \leq_j h_j(\beta)$  and  $f_j(\delta) <_j h_j(\varphi_2)$ . By (P2), it follows that  $f_j(\delta) \neq h_j(\beta)$ ; moreover, it is not true that  $f_j(\delta) = h_j(\alpha)$ , otherwise, by definition of p-morphism,  $h_{j+1}(\alpha)$  would have depth greater than the one of  $h_j(\alpha)$ , in

contradiction with (P3). Thus  $f_j(\delta) \in \mathcal{D}_j$  and (P6) holds. By (P6) and by the fact that each  $\mathcal{D}_j$  is finite, we can choose an infinite sequence of points  $\delta_{\bar{n}} \in \mathcal{D}_{\bar{n}}, \delta_{\bar{n}+1} \in \mathcal{D}_{\bar{n}+1}, \dots$  such that:

$$(*) \quad \delta_{\bar{n}} = f_{\bar{n}}(\delta_{\bar{n}+1}), \quad \delta_{\bar{n}+1} = f_{\bar{n}+1}(\delta_{\bar{n}+2}), \quad \dots$$

As a matter of fact, we can see the elements of the sets  $\mathcal{D}_j$ , for every  $j \geq \bar{n}$ , as the nodes of a tree  $T$ , where  $\delta_{j+1}$  is an immediate successor of  $\delta_j$  if and only if  $\delta_j = f_j(\delta_{j+1})$  (we also have to add a root  $\tau$  having, as immediate successors, all the elements of  $\mathcal{D}_{\bar{n}}$ ). Since  $T$  has infinitely many nodes and each node of  $T$  has finitely many immediate successors, by König Lemma (see for instance [11])  $T$  has an infinite branch; clearly the points  $\delta_{\bar{n}}, \delta_{\bar{n}+1}, \dots$  of this branch satisfy (\*). Such a sequence generates a point  $\delta^*$  of the limit  $\underline{K}$  of  $\mathcal{C}_K$  such that  $\alpha < \delta^* < \beta$ , against the fact that  $\beta$  is an immediate successor of  $\alpha$  in  $\underline{K}$ . Thus (P5) is proved. By (P5) and (P4) we get that  $h_{\bar{n}}(\beta) <_{\bar{n}} h_{\bar{n}}(\varphi_2)$ , in contradiction with (P2). This means that the initial hypothesis is false, hence  $L$  is canonical.  $\blacksquare$

The reader should notice how the above proof is rather complex and sophisticated mathematical arguments are required. This depends on the fact that, as we will see below, the logics **Ast** + **Bd** $_h$ , for  $h \geq 4$ , are *not extensively canonical*. Roughly speaking, the proof of canonicity of an extensively canonical logic  $L$  can be accomplished by a “reductio ad absurdum” in which one, basing himself on separability properties of a model  $\underline{K}$  of  $L$ , singles out “suitable formulas” in order to falsify in  $\underline{K}$  an instance of an axiom scheme of  $L$  (a typical example is the proof of Theorem 5.4). On the contrary, if  $L$  is not extensively canonical, one has to heavily use fullness hypothesis and “fill up” the model  $\underline{K}$  with new points in order to get a contradiction. Thus, passing from extensive canonicity to “pure” canonicity, there is a relevant increase of complexity in canonicity proofs.

We conclude by showing that, for every  $h \geq 4$ ,  $L = \mathbf{Ast} + \mathbf{Bd}_h$  is not extensively canonical. As a matter of fact, let us take the chain  $\mathcal{C} = \{\underline{P}_n, f_n\}_{n \geq 1}$ , where  $\underline{P}_n = \langle P_n, \leq_n, r \rangle$  and  $f_n$  are defined as follows (see Figure 14).

$$- P_n = \{r, a_1, \dots, a_n, \alpha, b_1, \dots, b_n, \beta, g_1, \dots, g_n, \gamma\}.$$

- The immediate successors of the root  $r$  are  $a_1, \dots, a_n, \alpha$ ; the immediate successors of  $\alpha$  are  $g_1, \dots, g_n$  and  $\beta$ ; the only immediate successor of  $\beta$  is  $\gamma$ .
- For  $1 \leq k \leq n$ , the immediate successors of  $a_k$  are  $g_1, \dots, g_{k-1}$  (if  $k \neq 1$ ) and  $b_k$ ; the immediate successors of  $b_k$  are  $g_k, \dots, g_n, \gamma$ .
- $f_n(a_{n+1}) = \alpha$ ,  $f_n(b_{n+1}) = \beta$ ,  $f_n(g_{n+1}) = \gamma$  and  $f_n(\delta) = \delta$  for all the other points  $\delta$ .

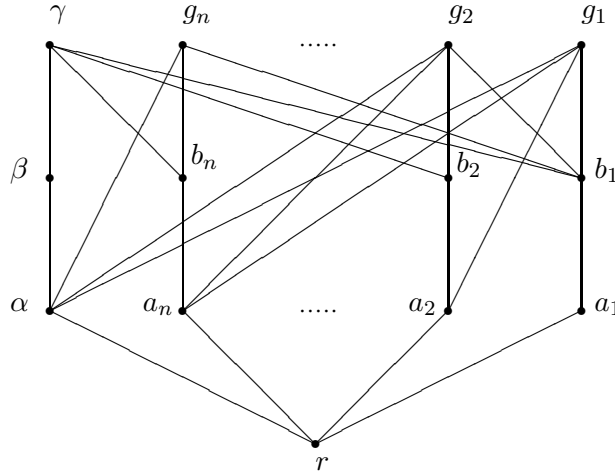
Figure 14: The frame  $\underline{P}_n$  for **Ast** + **Bd<sub>h</sub>**

Since  $\underline{P}_n$  is a frame for **Ast** (in fact, the immediate successors of  $r$  see the same final points) and since  $\text{depth}(\underline{P}_n) = 4$ , we can state that  $\underline{P}_n$  is a frame for  $L$ . Let  $\underline{P} = \langle P, \leq, r \rangle$  be the infinite frame defined as follows (see Figure 15).

- $P = \{r, a_1, a_2, \dots, b_1, b_2, \dots, \beta, g_1, g_2, \dots, \gamma\}$ .
- The immediate successors of the root  $r$  are the points  $a_n$ , for all  $n \geq 1$ , and  $\beta$ ; the only immediate successor of  $\beta$  is  $\gamma$ .
- For every  $n \geq 1$ , the immediate successors of  $a_n$  are  $g_1, \dots, g_{n-1}$  (if  $n \neq 1$ ) and  $b_n$ .
- The immediate successors of  $b_n$  are the points  $g_k$ , for all  $k \geq n$ , and  $\gamma$ .

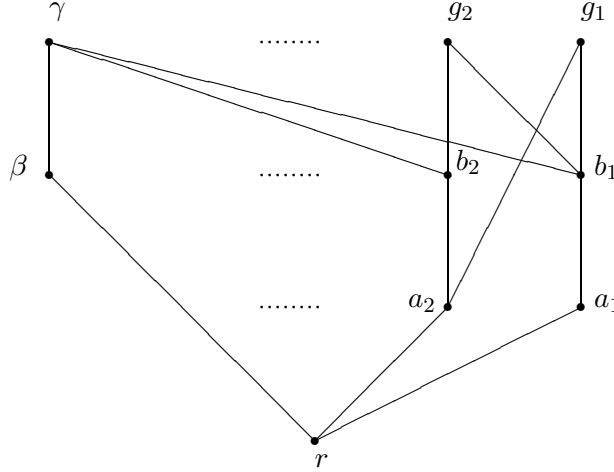
Figure 15: The well separable weak limit  $\underline{P}$ 

Then  $\underline{P}$  is a well separable weak limit of  $\mathcal{C}$  having projections  $\{h_n\}_{n \geq 1}$  defined as follows:

- $h_n(a_k) = \alpha$ ,  $h_n(b_k) = \beta$ ,  $h_n(g_k) = \gamma$ , for every  $k \geq n + 1$ ;
- $h_n(\delta) = \delta$  for all the other points  $\delta$ .

Since evidently  $\underline{P}$  is not a frame for **Ast**, by the Extensive Canonicity Criterion  $L$  is not extensively canonical. Clearly  $\underline{P}$  is not isomorphic to the limit of  $\mathcal{C}$  since, taking the points  $\alpha \in P_1, \alpha \in P_2, \dots$  we have that  $h_n(\alpha) = \alpha$  for every  $n \geq 1$ , but there is not any point  $\delta$  of  $\underline{P}$  such that  $h_n(\delta) = \alpha$  for all  $n \geq 1$ . To obtain the limit, we have to insert in  $\underline{P}$  a point  $\alpha$  such that  $\alpha$  is an immediate successor of  $r$  and  $\beta, g_1, g_2, \dots$  are all the immediate successors of  $\alpha$ . One can also check that such a frame is actually a frame for  $L$ , according to the fact that  $L$  is canonical and to the Canonicity Criterion.

## 6. The Medvedev logic

The Medvedev logic **MV** is known in literature as the logic of *finite problems* [14, 15, 16], and it arises in the framework of algorithmic interpretation of intuitionistic connectives (see [3] for more references). Here we are interested in the Kripke semantics of such a logic. Let  $X$  be a nonempty finite set; the *Medvedev frame* (shortly, *MV-frame*) determined by  $X$  is the frame  $\underline{P} = \langle P, \leq \rangle$  defined as follows:

- $P = \{Y : Y \subseteq X \text{ and } Y \neq \emptyset\}$ ;
- $Y \leq Z$  iff  $Z \subseteq Y$ .

Note that  $X$  is the root of  $\underline{P}$ , while the sets  $\{x\}$ , for each  $x \in X$ , are the final points of  $\underline{P}$ . For instance, for  $X_2 = \{a, b\}$  and  $X_3 = \{a, b, c\}$ , the corresponding  $MV$ -frames are represented in Figure 16.

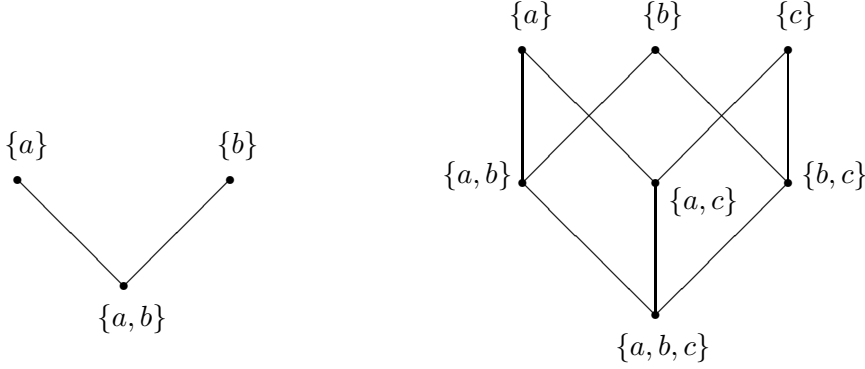

Figure 16: The  $MV$ -frames with 2 and 3 final points

Let  $\mathcal{F}_{MV}$  be the class of all the  $MV$ -frames; then we call

$$\mathbf{MV} = \mathcal{L}(\mathcal{F}_{MV}).$$

By definition, it immediately follows that  $\mathbf{St} \subseteq \mathbf{MV}$ . We point out that no axiomatization for this logic is known, it is only proved that  $\mathbf{MV}$  is not finitely axiomatizable (see: [13]); thus the problem of its decidability is still open.

### 6.1. Non extensive canonicity of $\mathbf{MV}$

Let, for each  $n \geq 1$ ,  $X_n = \{1, \dots, n\}$  and let us consider the chain of frames  $\mathcal{C} = \{\underline{P}_n, f_n\}_{n \geq 1}$  defined as follows:

- $\underline{P}_n$  is the  $MV$ -frame determined by  $X_n$ ;
- for every  $Y \in P_{n+1}$ ,  $f_n(Y) = \{s_n(y) : y \in Y\}$

where  $s_n(y) = y$  if  $y \leq n$ ,  $s_n(y) = n$  otherwise. Note that, by definition of  $MV$ -frame, the possible p-morphisms from  $\underline{P}_{n+1}$  onto  $\underline{P}_n$  are trivial permutations of  $f_n$ . Let  $X^+ = \mathbb{N} \cup \{\omega\}$  (where  $\mathbb{N}$  is the set of natural numbers) and let  $\underline{P} = \langle P, \leq \rangle$  be the frame defined as follows:

- $P = \{X_n : n \geq 1\} \cup \{\{\omega\}\} \cup \{X^+\}$ ;
- for every  $Y, Z \in P$ ,  $Y \leq Z$  iff  $Z \subseteq Y$ .

Note that  $X^+$  is the root of  $\underline{P}$  and  $\{\omega\}$  is the only immediate successor of  $X^+$  (see Figure 17). We claim that  $\underline{P}$  is a well separable weak limit of  $\mathcal{C}$

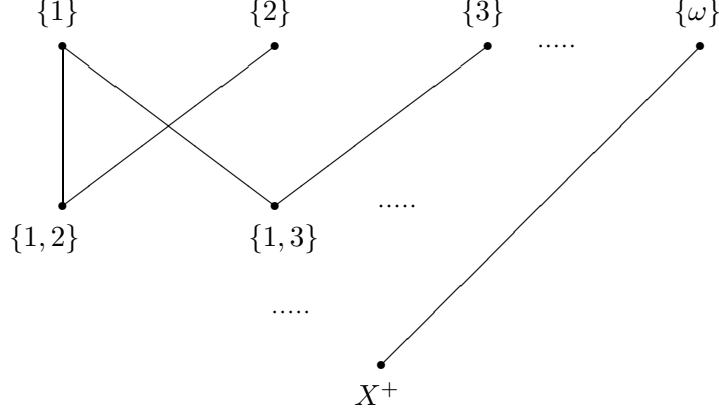

Figure 17: The well separable weak limit  $\underline{P}$

with projections  $\{h_n\}_{n \geq 1}$  defined as follows:

- for every  $Y \in P$ ,  $h_n(Y) = \{s_n^+(y) : y \in Y\}$

where  $s_n^+(y) = s_n(y)$  if  $y \in \mathbb{N}$ , and  $s_n^+(\omega) = n$ . One can easily see that  $\underline{P}$  is not a frame for **St**; a fortiori, it is not even a frame for **MV**. By the Extensive Canonicity Criterion, we can conclude that:

**Theorem 6.1.** *The Medvedev logic **MV** is not extensively canonical.*

Note that, to obtain the limit  $\underline{P}^*$  of  $\mathcal{C}$ , we have to add all the sets of the kind  $X_n \cup \{\omega\}$ ; we can apply Proposition 2.1 and state that  $\underline{P}^*$  is a frame for **MV**. Thus, we cannot use this kind of chains in order to disprove the canonicity of **MV**, and the question, as far as we know, remains open.

## 7. The logic of rhombuses

The so called *logic of rhombuses* **RH** presents some analogies with Medvedev logic, even if it is less known and less investigated in literature. As for **MV**, we give a semantical characterization (see [2, 3, 7, 12]). Let  $T$  be a linear ordering; an *interval* of  $T$  is a pair  $[t_1, t_2]$ , with  $t_1 \leq t_2$  (we will denote the interval  $[t, t]$  simply by  $t$ ). The ordering on  $T$  induces, in an

obvious way, a partial ordering  $\subseteq$  on the intervals of  $T$  (which intuitively corresponds to the containment relation) defined in the following way:

$$[t_1, t_2] \subseteq [u_1, u_2] \text{ iff } u_1 \leq t_1 \text{ and } t_2 \leq u_2.$$

Let  $T$  be a finite linear ordering; the  $RH$ -frame  $\underline{P} = \langle P, \leq \rangle$  determined by  $T$  is defined as follows:

- $P = \{[t_1, t_2] : t_1, t_2 \in T \text{ and } t_1 \leq t_2\}$ ;
- $[t_1, t_2] \leq [u_1, u_2]$  iff  $[u_1, u_2] \subseteq [t_1, t_2]$ .

Note that the intervals of the kind  $[t, t]$  are the final points of  $\underline{P}$  and the interval corresponding to the endpoints of  $T$  is the root of  $\underline{P}$ . For instance, if  $T = \{t_1, t_2, t_3, t_4\}$ , with  $t_1 < t_2 < t_3 < t_4$ , the  $RH$ -frame determined by  $T$  looks as in Figure 18.

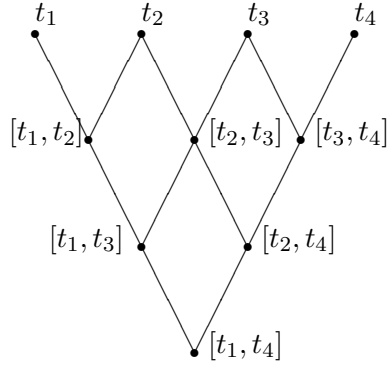

Figure 18: The  $RH$ -frame with 4 final points

Let  $\mathcal{F}_{RH}$  be the class of all the  $RH$ -frames; then we define

$$\mathbf{RH} = \mathcal{L}(\mathcal{F}_{RH}).$$

Clearly  $\mathbf{St} \subseteq \mathbf{RH}$ . We point out that the logics  $\mathbf{MV}$  and  $\mathbf{RH}$  are incomparable; as a matter of fact, let us consider the formulas  $\mathbf{kp}$  and  $\mathbf{bb}_2$  defined as follows (see also [3]):

$$\begin{aligned} \mathbf{kp} &= (\neg p \rightarrow q \vee r) \rightarrow (\neg p \rightarrow q) \vee (\neg p \rightarrow r) \\ \mathbf{bb}_2 &= \bigwedge_{i=0}^2 ((p_i \rightarrow \bigvee_{j \neq i} p_j) \rightarrow \bigvee_{j \neq i} p_j) \rightarrow \bigvee_{i=0}^2 p_i \end{aligned}$$

Then one can prove that:

$$\mathbf{kp} \in \mathbf{MV} \quad \mathbf{kp} \notin \mathbf{RH} \quad \mathbf{bb}_2 \in \mathbf{RH} \quad \mathbf{bb}_2 \notin \mathbf{MV}$$

We also point out that **MV** is maximal between the logics closed under disjunction (see [3]), while **RH** does not enjoy this property (see [7], where a logic closed under disjunction which properly extends **RH** is exhibited). Also for **RH** no axiomatization is known.

### 7.1. Non canonicity of the logic of rhombuses

In this section we prove that **RH** is not canonical. Let  $T^+$  be linearly ordered set  $\{1, 2, \dots, n, \dots, \omega\}$ . We define a chain of frames  $\mathcal{C} = \{\underline{P}_n, f_n\}_{n \geq 1}$ , where  $\underline{P}_n$  is the *RH*-frame defined on the linear ordering  $T_n = \{1, 2, \dots, n, \omega\}$ ; the p-morphism  $f_n$  from  $\underline{P}_{n+1}$  onto  $\underline{P}_n$  is defined in an obvious way. More precisely, let  $g_n$  be the map on the integers defined as follows:

- $g_n(k) = k$  if  $k \leq n$ ;
- $g_n(k) = \omega$  if  $k > n$ .

Then,  $f_n([k, l]) = [g_n(k), g_n(l)]$ . The limit  $\underline{P}^* = \langle P^*, \leq^* \rangle$  of  $\mathcal{C}$  is isomorphic to the frame  $\underline{P} = \langle P, \leq \rangle$  defined as follow: (see Figure 19):

- $P = \{[a, b] : a, b \in T^+ \text{ and } a \leq b\}$ ;
- $[a, b] \leq [c, d]$  iff  $[c, d] \subseteq [a, b]$ .

We point out that  $[1, \omega]$  is the root of  $\underline{P}$  and the stable points of  $\underline{P}$  are the

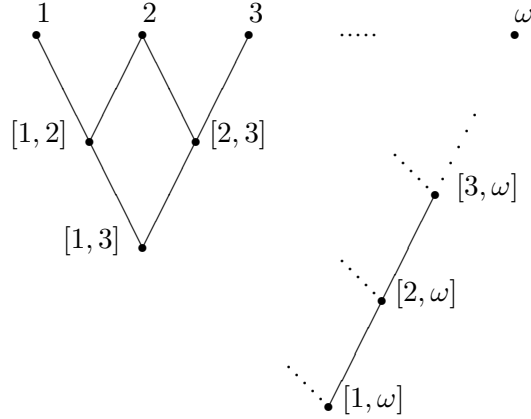

Figure 19: The limit  $\underline{P}$

ones of the kind  $[a, b]$  with  $b < \omega$ . It is easy to see that  $\underline{P}$  is not a frame for **St**, indeed we can define a p-morphism  $g$  from  $\underline{P}$  onto  $\underline{P}_{\sigma_5}$  as follows:

- $g(k) = \sigma_1$  if  $k < \omega$  (where  $k$ , as usual, denotes the interval  $[k, k]$ );



- $g(\omega) = \sigma_2$ ;
- $g([k, l]) = \sigma_3$  if  $k \neq l$  and  $l \neq \omega$ ;
- $g([k, \omega]) = \sigma_5$  if  $k \neq \omega$ .

We stress that  $g$  does not produce a stable reduction and, with this kind of chains, it seems difficult to find a counterexample which allows us to apply the Strong Completeness Criterion. In the present case, for instance, we can even find a weak limit  $\underline{P}'$  of  $\mathcal{C}$  which is a frame for **RH**. As a matter of fact, let  $\underline{P}'$  be the subframe of  $\underline{P}$  obtained by considering the point  $[1, \omega]$  and all the stable points of  $\underline{P}$ . Then, it is easy to check that  $\underline{P}'$  is a (well separable) weak limit of  $\mathcal{C}$ . Moreover, it is immediate to see that  $\underline{P}'$  has the filter property, therefore, by Proposition 2.1,  $\underline{P}'$  is a frame for **RH**. Thus, as a consequence of Proposition 4.5, all the stable reductions of the limit  $\underline{P}$  of  $\mathcal{C}$  are frames for **RH**. Also in this case, to strengthen the result we need more knowledge about the semantics of **RH**.

## 8. Other notions of subcanonicity

We briefly outline how one can further refine the analysis about canonicity, if we take into account the class of *all* Kripke models, including also models without enough final points. We can strengthen the notion of hypercanonicity and extensive canonicity in the following way:

- (a')  $L$  is *fully hypercanonical* iff the underlying frame of any separable Kripke model (possibly without enough final points) of  $L$  is a frame for  $L$ .
- (b')  $L$  is *fully extensively canonical* iff the underlying frame of any well separable Kripke model (possibly without enough final points) of  $L$  is a frame for  $L$ .

We stress that full hypercanonicity corresponds to *Df-persistence* (persistence for differentiated general frames), while full extensive canonicity corresponds to *R-persistence* (persistence for refined general frames), where these notions are well-known in the literature of both modal and intermediate logics (see for instance [3, 18]). These “full” notions are actually stronger than the previous ones. To show this, let **Jn** be the weak excluded middle logic described in Section 5; then:

- (1) **Jn** is hypercanonical (hence extensively canonical);
- (2) **Jn** is not fully extensively canonical (hence neither fully hypercanonical).

To prove (1), suppose by absurd that there is a separable Kripke model with enough final points  $\underline{K} = \langle P, \leq, \Vdash \rangle$  of **Jn** such that  $\underline{P} = \langle P, \leq \rangle$  is not directed. Then there must be  $\alpha \in P$  and two distinct final points  $\varphi_1, \varphi_2$  such that  $\alpha < \varphi_1$  and  $\alpha < \varphi_2$ . By the separability of  $\underline{K}$ , there is a formula  $A$  such that  $\varphi_1 \Vdash A$  and  $\varphi_2 \Vdash \neg A$ ; this implies  $\alpha \not\Vdash \neg A \vee \neg\neg A$ , against the fact that  $\underline{K}$  is a model of **Jn**.

To prove (2), let us consider the model  $\underline{K} = \langle P, \leq, \rho, \Vdash \rangle$ , where  $\underline{P} = \langle P, \leq, \rho \rangle$  is the frame in Figure 20 and  $\Vdash$  is defined as follows (we assume that  $p_0, p_1, \dots, q_0, q_1, \dots$  are all the variables of the language  $\mathcal{L}_V$ ):

- $\delta \Vdash p_k$  iff either  $\alpha_k \leq \delta$  or  $\beta_0 \leq \delta$ ;
- $\delta \Vdash q_k$  iff either  $\beta_k \leq \delta$  or  $\alpha_0 \leq \delta$ .

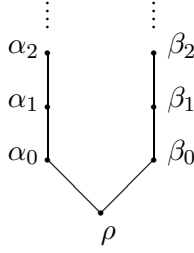

Figure 20: The non strongly directed frame  $\underline{P}$

Let  $V_k = \{p_0, \dots, p_k, q_0, \dots, q_k\}$ ; then, for every  $k \geq 0$ , it holds that:

$$\Gamma_{\underline{K}}^{V_k}(\alpha_k) = \Gamma_{\underline{K}}^{V_k}(\beta_k).$$

This implies that, for every formula  $A$ ,  $\rho \Vdash \neg A \vee \neg\neg A$ , hence  $\underline{K}$  is a model of **Jn**. On the other hand, even if  $\underline{K}$  is well separable,  $\underline{K}$  is not strongly directed (of course,  $\underline{K}$  is not even full, since the final point realizing the consistent saturated set  $\Phi = \bigcup_{k \geq 0} \Gamma_{\underline{K}}^{V_k}(\alpha_k)$  lacks). Thus, Df-persistence and R-persistence characterize the non-trivial class of canonical logics such that the hypothesis on final points is essential in canonicity proof. To complete the picture, we mention other minor results (see also [8]):

- the *logics of bounded depth*  $\mathbf{Bd}_h$  are fully hypercanonical;
- *Dummett logic* (or *Chain logic*)  $\mathbf{LC} = \mathbf{Int} + (p \rightarrow q) \vee (q \rightarrow p)$  is fully extensively canonical but not hypercanonical;
- *Kreisel-Putnam logic*  $\mathbf{KP} = \mathbf{Int} + \mathbf{kp}$  is canonical but not extensively canonical.

Thus, the classes above described do not collapse. Again, we stress that we are not interested in such a rich classification since the only relevant gap is the one between extensive canonicity and “pure” canonicity (see the discussion after the proof of Theorem 5.12).

To conclude, we think that the methods here developed have a general validity and can be extended in many other cases where Kripke semantics is used; for instance, there are not real difficulties in adapting the tools here used to modal logics (see also [10]), and many proofs of non canonicity and of non strong completeness of modal logics (perhaps, also of temporal logics) could be simplified.

## 9. Acknowledgments

The present paper reports much of the results developed in my PhD Thesis [8] (other advanced results are expounded in [9]). Thus, it is right and fair to mention who helped me in this research. First of all, Pierangelo Miglioli (1946-1999), who supervised the whole job, then Valentin Shehtman and Silvio Ghilardi for their careful revision.

Finally, I’m grateful to the anonymous referee for his valuable suggestions to the paper.

## References

- [1] J.G. Anderson, *Superconstructive propositional calculi with extra schemes containing one variable*, *Zeitschrift für Mathematische Logik und Grundlagen der Mathematik*, **18** (1972), 113–130.
- [2] A. Chagrov and M. Zakharyashev, *The disjunction property of intermediate propositional logics*, *Studia Logica*, **50** (2) (1991), 189–216.
- [3] A. Chagrov and M. Zakharyashev, *Modal Logic*, Oxford University Press, 1997.
- [4] C.C. Chang and H.J. Keisler, *Model Theory*, North-Holland, 1973.

- [5] M.J. Cresswell and G.E. Hughes, *An Introduction to Modal Logic*, Methuen, London, 1968.
- [6] M. Ferrari and P. Miglioli, *A method to single out maximal propositional logics with the disjunction property I*, *Annals of Pure and Applied Logic*, **76** (1995), 1–46.
- [7] M. Ferrari and P. Miglioli, *A method to single out maximal propositional logics with the disjunction property II*, *Annals of Pure and Applied Logic*, **76** (1995), 117–168.
- [8] C. Fiorentini, *Kripke Completeness for Intermediate Logics*, PhD thesis, Dipartimento di Scienze dell’Informazione, Università degli Studi di Milano, Italy, 1999. (available at <http://gongolo.usr.dsi.unimi.it/fiorenti>)
- [9] C. Fiorentini, *All intermediate logics with extra axioms in one variable, except eight, are not strongly  $\omega$ -complete*, *The Journal of Symbolic Logic*, **65**(3) (2000), 1576–1604.
- [10] S. Ghilardi and P. Miglioli, *On canonicity and strong completeness conditions in intermediate propositional logics*, *Studia Logica*, **63** (1999), 353–385.
- [11] A. Levy, *Basic Set Theory*, Springer-Verlag, Berlin, 1979.
- [12] L.L. Maksimova, *On the maximal intermediate logics with the disjunction property*, *Studia Logica*, **45** (1986), 69–75.
- [13] L.L. Maksimova, Shehtman, and D.P. Skvortsov, *The impossibility of a finite axiomatization of Medvedev’s logic of finitary problems*, *Soviet Mathematics Doklady*, **20** (2) (1979), 394–398.
- [14] Ju.T. Medvedev, *Finite problems*, *Soviet Mathematics Doklady*, **3** (1962), 227–230.
- [15] Ju.T. Medvedev, *Interpretation of logical formulas by means of finite problems and its relation to the realizability theory*, *Soviet Mathematics Doklady*, **4** (1963), 180–183.
- [16] Ju.T. Medvedev, *Interpretation of logical formulas by means of finite problems*, *Soviet Mathematics Doklady*, **7** (1966), 857–860.
- [17] I. Nishimura, *On formulas of one variable in intuitionistic propositional calculus*, *The Journal of Symbolic Logic*, **25** (1960), 327–331.
- [18] G. Sambin and V. Vaccaro, *Topology and duality in modal logic*, *Ann. Pure Appl. Logic*, **37** (3) (1988), 249–296.
- [19] S.K. Sobolev, *On the finite approximability of superintuitionistic logics*, *Mathematics of USSR, Sbornik*, **31** (1977), 257–268.
- [20] F. Wolter, *Properties of tense logics*, *Math. Logic Quart.*, **42** (4) (1996), 481–500.

Dipartimento di Scienze dell’Informazione  
 Università degli Studi di Milano  
 via Comelico 39, 20135 Milano – Italy

e-mail: [fiorenti@dsi.unimi.it](mailto:fiorenti@dsi.unimi.it)